

Table of contents

1	INTRODUCTION	11
1.1	ATTENTION.....	11
1.2	INSTRUCTIONS OF SAFETY	11
1.3	LEGAL NOTICE	12
1.4	ABOUT DOCUMENT	12
2	BASIC DESCRIPTION	12
2.1	PACKAGE CONTENTS.....	12
2.2	BASIC CHARACTERISTICS	13
2.3	TECHNICAL FEATURES.....	15
2.4	TECHNICAL INFORMATION ABOUT INTERNAL BATTERY.....	17
2.5	ELECTRICAL CHARACTERISTICS.....	17
2.6	ABSOLUTE MAXIMUM RATINGS.....	19
3	CONNECTION, PINOUT, ACCESSORIES.....	20
3.1	HOW TO INSERT SIM CARD INTO FMB1YX DEVICE:	20
3.2	HOW TO ADD MICROSD CARD INTO FMB1YX DEVICE	21
3.3	INSTALLING FMB1YX DRIVERS	21
3.4	FMB120 AND FMB122 2X6 SOCKET PINOUT	23
3.5	FMB125 2X6 SOCKET PINOUT.....	24
3.6	ACCESSORIES.....	25
3.7	NAVIGATE LED.....	28
3.8	STATUS LED	28
4	OPERATIONAL BASICS.....	28
4.1	OPERATIONAL PRINCIPALS.....	28
4.2	SLEEP MODES.....	29
4.2.1	<i>GPS Sleep mode</i>	29
4.2.2	<i>Deep Sleep mode</i>	29
4.2.3	<i>Online Deep Sleep mode</i>	30
4.3	VIRTUAL ODOMETER.....	30
4.4	FEATURES.....	31
4.4.1	<i>ECO driving/Green driving Scenarios</i>	31
4.4.2	<i>OverSpeeding Scenario</i>	32
4.4.3	<i>Jamming detection</i>	32
4.4.4	<i>Trip</i>	32
4.4.5	<i>DOUT Control Via Call</i>	32
4.4.6	<i>Immobilizer</i>	32
4.4.7	<i>iButton read notification</i>	33
4.4.8	<i>GPS Fuel Counter</i>	33
4.5	ACCELEROMETER FEATURES	33
4.5.1	<i>Excessive Idling</i>	33
4.5.2	<i>Unplug Detection</i>	33
4.5.3	<i>Towing Detection</i>	33
4.5.4	<i>Crash Detection</i>	33
4.6	BLUETOOTH.....	33
4.7	AUTO GEOFENCE	34
4.8	MANUAL GEOFENCE.....	34
4.9	IBUTTON LIST	34
5	CONFIGURATION	34
5.1	CONFIGURATOR.....	34
5.1.1	<i>Main Buttons description:</i>	36
5.1.2	<i>Keyword SMS (GPRS) commands:</i>	36

5.1.3	<i>Keyword configuration with TCP</i>	36
5.2	STATUS INFO	36
5.3	SECURITY INFO	37
5.4	SYSTEM SETTINGS	37
5.5	GPRS	40
5.6	SMS/CALL SETTINGS	41
5.7	GSM OPERATORS, SIM1 ROAMING AND SIM2 ROAMING/ HOME OPERATOR LIST, BLACKLIST OPERATOR LIST	43
5.7.1	<i>Dual SIM</i>	44
5.8	DATA ACQUISITION MODE SETTINGS	46
5.9	FEATURES SETTINGS	48
5.9.1	<i>Green Driving</i>	49
5.9.1.1	Data output	50
5.9.1.2	Auto Calibaration	50
5.9.2	<i>Over Speeding</i>	51
5.9.3	<i>Jamming</i>	51
5.9.4	<i>Use authorized numbers to control DOUT via call</i>	52
5.9.5	<i>Immobilizer</i>	52
5.9.6	<i>iButton read notification</i>	53
5.9.7	<i>GPS Fuel Counter</i>	53
5.10	ACCELEROMETER FEATURES	53
5.10.1	<i>Excessive Idling</i>	54
5.10.2	<i>Unplug Detection</i>	54
5.10.3	<i>Towing Detection</i>	54
5.10.4	<i>Crash Detection</i>	55
5.11	DOUT ON/OFF DURATION	56
5.12	DOUT CONTROL DEPENDING ON FUNCTIONALITY PRIORITY	57
5.13	AUTOGEOFENCING SETTINGS	57
5.14	MANUAL GEOFENCE	58
5.15	TRIP \ ODOMETER	59
5.15.1	<i>Trip settings</i>	59
5.15.2	<i>Advanced Trip Settings</i>	60
5.15.3	<i>Odometer</i>	61
5.16	BLUETOOTH	62
5.16.1	<i>General functionality</i>	62
5.16.2	<i>How to connect Bluetooth Hands Free adapter to FMB device</i>	64
5.16.2.1	Bluetooth settings configuration	64
5.16.2.2	Connecting Bluetooth Hands Free adapter	66
5.16.3	<i>Device's log using your mobile phone</i>	66
5.16.4	<i>Device debug over Android smartphone</i>	67
5.16.5	<i>How to connect OBD II Bluetooth Dongle to FMB device</i>	68
5.16.5.1	Bluetooth settings configuration	68
5.16.5.2	Connecting to Bluetooth OBD II dongle	70
5.16.5.3	Supported Bluetooth OBD II dongles	71
5.17	SMS EVENTS	71
5.18	IBUTTON LIST	73
5.19	I/O SETTINGS	73
5.19.1	<i>Operand On Exit</i>	73
5.19.2	<i>Operand On Entrance</i>	74
5.19.3	<i>Operand On Both</i>	74
5.19.4	<i>Operand Monitoring</i>	74
5.19.5	<i>Operand On Hysteresis</i>	75
5.19.6	<i>Operand On Change</i>	75
5.19.7	<i>Operand On Delta Change</i>	75
5.19.8	<i>Avg const (Averaging parameter description)</i>	75
5.19.9	<i>OBD II (Bluetooth) and LVCAN I/O elements</i>	76
5.19.10	<i>FMB125 RS232\RS485 parameters configuration</i>	76
5.19.10.1	External UART working mode	76
5.19.10.2	RS232 working mode	77

5.19.10.3	RS232 Baudrate and parity	77
5.19.10.4	RS232 TCP Binary mode settings	78
5.19.10.5	RS232 Garmin Mode settings	78
5.19.10.6	RS485 working mode	78
5.19.10.7	RS485 Baudrate	79
5.19.10.8	RS485 LLS Sensors.....	79
6	RS232 AND RS485	79
6.1	RS485 INTERFACE	79
6.2	RS485 MODES.....	80
6.2.1	<i>RS485 transmit (FMB log) mode.....</i>	<i>80</i>
6.2.2	<i>RS485 transmit (GNSS NMEA) mode</i>	<i>80</i>
6.2.3	<i>RS485 receive (LLS) mode</i>	<i>81</i>
6.2.4	<i>RS485 TCP (ASCII, Binary) mode</i>	<i>81</i>
6.3	RS232 INTERFACE	81
6.4	RS232 MODES.....	81
6.4.1	<i>RS232 LCD mode.....</i>	<i>81</i>
6.4.2	<i>RS232 RFID HID/RFID MF7 mode.....</i>	<i>82</i>
6.4.3	<i>RS232 GARMIN mode.....</i>	<i>83</i>
6.5	GARMIN PROTOCOLS	84
6.5.1	<i>Standard protocols</i>	<i>84</i>
6.5.2	<i>Enhanced protocols.....</i>	<i>85</i>
6.5.3	<i>Supported features on TAVL client application</i>	<i>85</i>
6.5.4	<i>Text messaging.....</i>	<i>85</i>
6.5.5	<i>Destination message</i>	<i>85</i>
6.5.6	<i>ETA request message.....</i>	<i>85</i>
7	FMB1YX WITH LV-CAN200 AND ALL-CAN300 CAN ADAPTERS	85
7.1	PURPOSE OF CAN ADAPTERS LV-CAN200 AND ALL-CAN30	85
7.2	LV-CAN200 AND ALL-CAN300 PROGRAM NUMBER SELECTION	86
7.2.1	<i>LV-CAN200 and ALL-CAN300 program number configuration via SMS command.</i>	<i>86</i>
7.2.2	<i>LV-CAN200 and ALL-CAN300 program number configuration via configurator</i>	<i>86</i>
7.2.3	<i>Selecting LV-CAN200 and ALL-CAN300 program number manually</i>	<i>86</i>
7.3	SIMPLE-CAN - CONTACTLESS CAN-BUS READER.....	88
7.4	CONNECTING FMB1YX CAN ADAPTERS ALL-CAN300 AND LV-CAN200	89
7.5	FMB1YX ALL-CAN300 AND LV-CAN200 PARAMETERS CONFIGURATION.....	90
7.6	SEND DATA WITH 0, IF IGNITION IS OFF	94
8	SMS/GPRS COMMAND LIST	95
8.1	SMS/GPRS COMMAND LIST.....	95
8.1.1	<i>getinfo</i>	<i>98</i>
8.1.2	<i>getver</i>	<i>99</i>
8.1.3	<i>getstatus.....</i>	<i>99</i>
8.1.4	<i>getgps.....</i>	<i>99</i>
8.1.5	<i>getio.....</i>	<i>100</i>
8.1.6	<i>ggps</i>	<i>100</i>
8.1.7	<i>radio #.....</i>	<i>100</i>
8.1.8	<i>getparam.....</i>	<i>100</i>
8.1.9	<i>setparam</i>	<i>100</i>
8.1.10	<i>flush #,#,#,#,#,#</i>	<i>101</i>
8.1.11	<i>countrecs</i>	<i>101</i>
8.1.12	<i>deleterecords.....</i>	<i>101</i>
8.1.13	<i>setdigout.....</i>	<i>102</i>
8.1.14	<i>battery.....</i>	<i>102</i>
8.1.15	<i>fc_reset.....</i>	<i>102</i>
8.1.16	<i>towingreact</i>	<i>102</i>
8.1.17	<i>odoset:#.....</i>	<i>102</i>
8.1.18	<i>odoget</i>	<i>102</i>

8.1.19	<i>btgetlist #</i>	102
8.1.20	<i>obdinfo</i>	103
8.1.21	<i>faultcodes</i>	103
8.1.22	<i>setkey # #</i>	103
8.1.23	<i>delkey # #</i>	103
8.1.24	<i>bbread #</i>	103
8.1.25	<i>bbinfo #</i>	103
8.1.26	<i>sdformat</i>	104
8.1.27	<i>lvcansetprog #</i>	104
8.1.28	<i>lvcangetprog</i>	104
8.1.29	<i>lvcangetinfo</i>	104
8.1.30	<i>lvcanclear #</i>	104
8.1.31	<i>allcanmode</i>	104
8.1.32	<i>lvcanmode</i>	104
8.1.33	<i>lvcanfaultcodes</i>	104
9	PARAMETER LIST	105
9.1	SYSTEM PARAMETERS	105
9.1.1	<i>Sleep Mode (ID=102)</i>	105
9.1.2	<i>Sleep timeout (ID=103)</i>	105
9.1.3	<i>Movement Source (ID=100)</i>	105
9.1.4	<i>Static Navigation (ID=106)</i>	105
9.1.5	<i>Analog input value range (ID=111)</i>	106
9.1.6	<i>Static Navigation Settings (ID=112)</i>	106
9.1.7	<i>Saving/Sending without time synchronization (ID=107)</i>	106
9.1.8	<i>GNSS Source (ID=109)</i>	106
9.1.9	<i>Ignition settings (ID=101)</i>	106
9.1.10	<i>High voltage level (ID=104)</i>	107
9.1.11	<i>Low voltage level (ID=105)</i>	107
9.1.12	<i>Movement Start Delay(s) (ID=19001)</i>	107
9.1.13	<i>Movement Stop Delay(s) (ID=19002)</i>	108
9.1.14	<i>Led indication (ID=108)</i>	108
9.1.15	<i>Synchronization settings (ID=900)</i>	108
9.1.16	<i>NTP Resync (ID=901)</i>	108
9.1.17	<i>NTP server 1 (ID=902)</i>	108
9.1.18	<i>NTP server 2 (ID=903)</i>	109
9.1.19	<i>Battery charge mode (ID=110)</i>	109
9.2	GPRS PARAMETERS	109
9.2.1	<i>Sorting (ID=1002)</i>	109
9.2.2	<i>Open Link Timeout (ID=1000)</i>	109
9.2.3	<i>Server Response Timeout (ID=1001)</i>	109
9.2.4	<i>SIM1 GPRS content activation (ID=2000)</i>	110
9.2.5	<i>SIM1 APN Name (ID=2001)</i>	110
9.2.6	<i>SIM1 APN username (ID=2002)</i>	110
9.2.7	<i>SIM1 APN Password (ID=2003)</i>	111
9.2.8	<i>SIM2 GPRS content activation (ID=2011)</i>	111
9.2.9	<i>SIM2 APN Name (ID=2012)</i>	111
9.2.10	<i>SIM2 APN username (ID=2013)</i>	111
9.2.11	<i>SIM2 APN Password (ID=2014)</i>	112
9.2.12	<i>Domain (ID=2004)</i>	112
9.2.13	<i>Target Server Port (ID=2005)</i>	112
9.2.14	<i>Protocol (ID=2006)</i>	112
9.2.15	<i>Backup Server Domain (ID=2007)</i>	112
9.2.16	<i>Backup Server Port (ID=2008)</i>	112
9.2.17	<i>Backup Server Protocol (ID=2009)</i>	113
9.2.18	<i>Backup Server Mode (ID=2010)</i>	113
9.2.19	<i>FOTA WEB status (ID=13003)</i>	113
9.2.20	<i>FOTA WEB Domain (ID=13000)</i>	113

9.2.21	FOTA WEB port (ID=13001)	113
9.2.22	FOTA WEB Period (min) (ID=13002)	114
9.3	SMS/CALL SETTINGS	114
9.3.1	SMS data sending settings (ID=3000).....	114
9.3.2	Data send number (ID=3001)	114
9.3.3	Authorized phone numbers (ID=4000-4199)	114
9.3.4	GSM Predefined Numbers (ID=6000-6009)	114
9.3.5	SMS Login (ID=3003)	115
9.3.6	SMS Password (ID=3004).....	115
9.3.7	Incoming call action (ID=3005).....	115
9.3.8	SMS Event Time Zone (ID=3006).....	116
9.3.9	Hands Free Call Settings (ID=3007)	116
9.3.10	GSM number index (ID=3008)	116
9.4	GSM OPERATORS.....	116
9.4.1	SIM1 Roaming Operator List (ID=5000-5049)	116
9.4.2	SIM2 Roaming/ Home Operator List (ID=9500-9549)	117
9.4.3	Black List (ID=5500-5549).....	117
9.5	DATA ACQUISITION MODES PARAMETERS.....	117
9.5.1	Home Network GSM operator code "Vehicle on STOP" parameters.....	117
9.5.1.1	Min Period (ID=10000).....	117
9.5.1.2	Min Saved Records (ID=10004).....	117
9.5.1.3	Send Period (ID=10005)	117
9.5.2	Home Network GSM operator code "Vehicle MOVING" parameters.....	118
9.5.2.1	Min Period (ID=10050).....	118
9.5.2.2	Min Distance (ID=10051)	118
9.5.2.3	Min Angle (ID=10052).....	118
9.5.2.4	Min Speed Delta (ID=10053).....	119
9.5.2.5	Min Saved Records (ID=10054).....	119
9.5.2.6	Send Period (ID=10055)	119
9.5.3	Roaming Network GSM operator code "Vehicle on STOP" parameters	119
9.5.3.1	Min Period (ID=10100).....	119
9.5.3.2	Min Saved Records (ID=10104).....	120
9.5.3.3	Send Period (ID=10105)	120
9.5.4	Roaming Network GSM operator code "Vehicle MOVING" parameters	120
9.5.4.1	Min Period (ID=10150).....	120
9.5.4.2	Min Distance (ID=10151)	120
9.5.4.3	Min Angle (ID=10152).....	121
9.5.4.4	Min Speed Delta (ID=10153).....	121
9.5.4.5	Min Saved Records (ID=10154).....	121
9.5.4.6	Send Period (ID=10155)	121
9.5.5	Unknown Network GSM operator code "Vehicle on STOP" parameters	122
9.5.5.1	Min Period (ID=10200).....	122
9.5.5.2	Min Saved Records (ID=10204).....	122
9.5.5.3	Send Period (ID=10205)	122
9.5.6	Unknown Network GSM operator code "Vehicle MOVING" parameters	122
9.5.6.1	Min Period (ID=10250).....	122
9.5.6.2	Min Distance (ID=10251)	123
9.5.6.3	Min Angle (ID=10252).....	123
9.5.6.4	Min Speed (ID=10253).....	123
9.5.6.5	Min Saved Records (ID=10254).....	123
9.5.6.6	Send Period (ID=10255)	124
9.6	FEATURES PARAMETERS	124
9.6.1	Green driving parameters.....	124
9.6.1.1	Green driving priority (ID=11000).....	124
9.6.1.2	Max Acceleration Force (ID=11004)	124
9.6.1.3	Max Braking Force (ID=11005).....	125
9.6.1.4	Max Cornering (ID=11006).....	125
9.6.1.5	Green/Eco driving (ID=11007)	126
9.6.1.6	Green driving digital output control settings (ID=11003)	126
9.6.1.7	Green driving Digital output on duration (ID=11001).....	127
9.6.1.8	Green driving Digital output off duration (ID=11002)	127

9.6.1.9	Green driving Send SMS to (ID=7034)	128
9.6.1.10	Green driving SMS text (ID=8034)	128
9.6.2	<i>Overspeeding scenario parameters</i>	129
9.6.2.1	Overspeeding priority (ID=11100)	129
9.6.2.2	Max allowed Speed (ID=11104)	129
9.6.2.3	Overspeeding output control (ID=11103)	130
9.6.2.4	Overspeeding Digital output on duration (ID=11101)	130
9.6.2.5	Overspeeding Digital output off duration (ID=11102)	130
9.6.2.6	Overspeeding Send SMS To (ID=7032)	131
9.6.2.7	Overspeeding SMS Text (ID=8032)	131
9.6.3	<i>Jamming scenario parameters</i>	132
9.6.3.1	Jamming priority (ID=11300)	132
9.6.3.2	Jamming Eventual records (ID=11303)	132
9.6.3.3	Jamming Output Control (ID=11304)	132
9.6.3.4	Time Until Jamming Event Detection(ID=11305)	133
9.6.3.5	Jamming DOUT on duration [ms] (ID=11301)	133
9.6.3.6	Jamming DOUT off duration [ms] (ID=11302)	133
9.6.4	<i>Immobilizer scenario parameters</i>	134
9.6.4.1	Scenario settings (ID=11700)	134
9.6.4.2	Eventual records (ID=11701)	134
9.6.4.3	Output control (ID=11702)	134
9.6.4.4	iButton list check (ID=11703)	134
9.6.4.5	Send SMS to (ID=7140)	135
9.6.4.6	SMS text (ID=8140)	135
9.6.5	<i>Trip scenario parameters</i>	135
9.6.5.1	Trip priority (ID=11800)	135
9.6.5.2	Eventually Records (ID=11801)	136
9.6.5.3	Trip mode (ID=11802)	136
9.6.5.4	Start Speed (ID=11803)	136
9.6.5.5	Ignition Off Timeout (ID=11804)	137
9.6.5.6	Eco Score allowed events (ID=700)	137
9.6.5.7	Trip Send SMS To (ID=7031)	137
9.6.5.8	Trip SMS Text (ID=8031)	138
9.6.5.9	Odometer distance calculation source (ID=11806)	138
9.6.5.10	Total Odometer value (ID=11807)	139
9.6.5.11	Remember iButton ID (ID=11805)	139
9.6.6	<i>DOUT control via call scenario parameters</i>	139
9.6.6.1	Digital Output control (ID=12000)	139
9.6.6.2	DOUT deactivation (ID=12001)	139
9.6.6.3	Duration timeout (ID=12002)	140
9.6.7	<i>iButton read notification</i>	140
9.6.7.1	Digital Output control (ID=11704)	140
9.6.7.2	Duration timeout [ms] (ID=11705)	140
9.7	AUTOGEOFENCING SCENARIO PARAMETERS	140
9.7.1	<i>AutoGeofencing priority (ID=20000)</i>	140
9.7.2	<i>Eventual Records (ID=20002)</i>	141
9.7.3	<i>Activation Timeout (ID=20003)</i>	141
9.7.4	<i>Deactivate by (ID=20005)</i>	141
9.7.5	<i>AutoGeofence event generating (ID=20001)</i>	142
9.7.6	<i>Radius (ID=20004)</i>	142
9.7.7	<i>AutoGeofence Send SMS to (ID=7030)</i>	142
9.7.8	<i>SMS Text (ID=8030)</i>	143
9.8	MANUAL GEOFENCE	143
9.8.1	<i>First Geozone parameters</i>	143
9.8.1.1	#1 Geozone Manual Geofencing priority (ID=20100)	143
9.8.1.2	#1 Geozone Manual Geofence event generating (ID=20101)	144
9.8.1.3	#1 Geozone Eventual Records (ID=20102)	144
9.8.1.4	#1 Geozone Frame border (ID=20103)	145
9.8.1.5	#1 Geozone Shape type (ID=20104)	145
9.8.1.6	#1 Geozone Radius (ID=20105)	146
9.8.1.7	#1 Geozone X1 (ID=20106)	146
9.8.1.8	#1 Geozone Y1 (ID=20107)	147

9.8.1.9	#1 Geozone X2 (ID=20108)	147
9.8.1.10	#1 Geozone X1 (ID=20109)	148
9.8.1.11	#1 Geozone OverSpeeding (ID=20110)	148
9.8.1.12	#1 Geozone Max allowed speed (ID=20111)	149
9.8.2	<i>Other Geozones</i>	149
9.8.2.1	Send sms to #1-5 Geozone (ID=7025-7029), #6-50 Geozone (ID=7071-7115)	150
9.8.2.2	SMS Text #1-5 Geozone (ID=8025-8029), #6-50 Geozone (ID=8071-8115)	150
9.9	GPS FUEL COUNTER	150
9.9.1	City Consumption L/100km (ID=11900)	150
9.9.2	Highway Consumption L/100km (ID=11901)	151
9.9.3	Average Consumption L/100km (ID=11902)	151
9.9.4	City Speed [km/h] (ID=11903)	152
9.9.5	Highway Speed [km/h] (ID=11904)	152
9.9.6	Average Speed [km/h] (ID=11905)	153
9.9.7	Correction coefficient (ID=11906)	153
9.9.8	Fuel Consumption on Idling [L/h] (ID=11907)	154
9.9.9	Higher Speeds Add [%] (ID=11908)	154
9.9.10	Highway Consumption every km/h (ID=11909)	155
9.10	ACCELEROMETER FEATURES	155
9.10.1	<i>Unplug Detection</i>	155
9.10.1.1	Scenario settings (ID=11500)	155
9.10.1.2	Eventual records (ID=11501)	156
9.10.1.3	Unplug detection mode (ID=11502)	156
9.10.1.4	Unplug send sms to (ID=7067)	156
9.10.1.5	SMS Text (ID=8067)	156
9.10.2	<i>Towing Detection</i>	157
9.10.2.1	Scenario setting (ID=11600)	157
9.10.2.2	Eventual Records (ID=11601)	157
9.10.2.3	Activation Timeout (min) (ID=11602)	157
9.10.2.4	Event Timeout (s) (ID=11603)	158
9.10.2.5	Towing Make Call(Sms Event Number ID) (ID=11604)	158
9.10.2.6	Treshold (mg) (ID=11605)	158
9.10.2.7	Angle (deg) (ID=11606)	159
9.10.2.8	Duration (msec) (ID=11607)	159
9.10.2.9	Towing Send SMS (ID=7066)	159
9.10.2.10	SMS Text (ID=8066)	160
9.10.3	<i>Crash Detection</i>	160
9.10.3.1	Scenario settings (ID=11400)	160
9.10.3.2	Duration [ms] (ID=11401)	161
9.10.3.3	Treshold [mG] (ID=11402)	161
9.10.3.4	Crash trace (ID=11406)	161
9.10.3.5	Crash sms send to (ID=7068)	161
9.10.3.6	SMS Text (ID=8068)	162
9.10.4	<i>Excessive idling</i>	162
9.10.4.1	Excessive idling priority (ID=11200)	162
9.10.4.2	Eventual records (ID=11203)	162
9.10.4.3	Excessive idling time to stopped (ID=11205)	163
9.10.4.4	Excessive idling time to moving (ID=11206)	164
9.10.4.5	Excessive idling output control (ID=11204)	164
9.10.4.6	Excessive idling output on duration (ID=11201)	165
9.10.4.7	Excessive idling output off duration (ID=11202)	165
9.10.4.8	Excessive idling Send SMS To (ID=7033)	166
9.10.4.9	Excessive idling SMS Text (ID=8033)	166
9.11	BLUETOOTH	167
9.11.1.1	BT Radio (ID=800)	167
9.11.1.2	Local name (ID 801)	167
9.11.1.3	Local PIN (ID=802)	167
9.11.1.4	Security mode (ID=803)	167
9.11.1.5	External MAC (ID=804)	168
9.11.1.6	External name (ID=805)	168
9.11.1.7	External PIN (ID=806)	168
9.11.1.8	Connection mode (ID=807)	169

9.11.1.9	Authorized devices MAC list (ID=830 - 834)	169
9.12	IBUTTON LIST (ID=30000 – 30500)	169
9.13	I/O PARAMETERS	170
9.13.1	I/O#1 property parameter priority Ignition (ID=50000)	170
9.13.2	I/O#1 operand (ID=50001)	170
9.13.3	I/O#1 High level (ID=50002)	170
9.13.4	I/O#1 Low level (ID=50003)	171
9.13.5	I/O#1 Event only (ID=50004)	171
9.13.6	I/O#1 averaging length (ID=50005)	171
9.13.7	I/O#1 send SMS (ID=7000)	172
9.13.8	I/O#1 SMS text (ID=8000)	172
9.13.9	I/O elements parameters and types	172
9.14	OBD II (BLUETOOTH)	181
9.14.1	1 st OBD II (Bluetooth) property parameter priority (ID=40100)	181
9.14.2	1 st OBD II (Bluetooth) property parameter operand (ID=40101)	182
9.14.3	1 st OBD II (Bluetooth) property parameter High level (ID=40102)	182
9.14.4	1 st OBD II (Bluetooth) property parameter Low level (ID=40103)	182
9.14.5	1 st OBD II (Bluetooth) property parameter Event only (ID=40104)	183
9.14.6	1 st OBD II (Bluetooth) property parameters Send SMS to (ID=7038)	183
9.14.7	1 st OBD II (Bluetooth) property parameters SMS Text (ID=8038)	184
9.14.8	All OBD II (Bluetooth) I/O elements parameters property ID	184
9.15	LVCAN	185
9.15.1	LVCAN Mode (ID = 45000)	185
9.15.2	Send data with 0, if ignition is off (ID = 45001)	185
9.15.3	Program Number (ID = 45002)	186
9.15.4	1 st LVCAN property parameter priority (ID=45100)	186
9.15.5	1 st LVCAN property parameter operand (ID=45101)	186
9.15.6	1 st LVCAN property parameter High level (ID=45102)	187
9.15.7	1 st LVCAN property parameter Low level (ID=45103)	187
9.15.8	1 st LVCAN property parameter Event only (ID=45104)	187
9.15.9	1 st LVCAN property parameter averaging constant (ID=45105)	188
9.15.10	1 st LVCAN property parameters Send SMS to (ID=7141)	188
9.15.11	1 st LVCAN property parameters SMS Text (ID=8141)	189
9.15.12	All LVCAN I/O elements parameters property ID	189
9.16	RS232\RS485	192
9.16.1	External UART working mode (ID=150)	192
9.16.2	RS232	192
9.16.2.1	RS232 working mode (ID=151)	192
9.16.2.2	RS232 Baudrate (ID=152)	192
9.16.2.3	RS232 Parity (ID=153)	193
9.16.3	RS232 TCP Binary Mode Settings	193
9.16.3.1	Prefix 1 (ID=154)	193
9.16.3.2	Prefix 2 (ID=155)	194
9.16.3.3	Prefix 3 (ID=156)	194
9.16.4	Garmin Mode Settings (ID=157)	194
9.16.5	RS485	195
9.16.5.1	RS485 working mode (ID=160)	195
9.16.5.2	RS485 Baudrate (ID=161)	195
9.16.6	RS485 LLS Sensors	195
9.16.6.1	LLS 1 Address (ID=162)	195
9.16.6.2	LLS 2 Address (ID=163)	196
9.16.6.3	LLS 3 Address (ID=164)	196
9.16.6.4	LLS 4 Address (ID=165)	196
9.16.6.5	LLS 5 Address (ID=166)	197
10	MOUNTING RECOMMENDATIONS	197
10.1	CONNECTING WIRES	197
10.2	CONNECTING POWER SOURCE	197
10.3	CONNECTING IGNITION WIRE	197

10.4	CONNECTING GROUND WIRE.....	197
11	FMB1YX INSTALLATION INSTRUCTION	198
12	DEBUG MODE.....	199
13	CHANGE LOG	201

1 INTRODUCTION

1.1 Attention



Do not disassemble the device. If the device is damaged, the power supply cables are not isolated or the isolation is damaged, before unplugging the power supply, do not touch the device.



All wireless data transferring devices produce interference that may affect other devices which are placed nearby.



The device must be connected only by qualified personnel.



The device must be firmly fastened in the predefined location.



The programming must be performed using a second class PC (with autonomic power supply).



The device is susceptible to water and humidity.



Any installation and/or handling during a lightning storm are prohibited.

1.2 Instructions of safety

This chapter contains information on how to operate FMB1YX safely. By following these requirements and recommendations, you will avoid dangerous situations. You must read these instructions carefully and follow them strictly before operating the device!

The device uses SELV limited power source. The nominal voltage is 12 V DC. The allowed range of voltage is 10 V...30 V DC.

To avoid mechanical damage, it is advised to transport the FMB1YX device in an impact-proof package. Before usage, the device should be placed so that its LED indicators are visible, which show the status of operation the device is in.

When connecting the connection (2x6) cables to the vehicle, the appropriate jumpers of the power supply of the vehicle should be disconnected.

Before dismounting the device from the vehicle, the 2x6 connection must be disconnected.

The device is designed to be mounted in a zone of limited access, which is inaccessible for the operator. All related devices must meet the requirements of standard EN 60950-1.

The device FMB1YX is not designed as a navigational device for boats.

1.3 Legal Notice

Copyright © 2017 Teltonika. All rights reserved. Reproduction, transfer, distribution or storage of part or all of the contents in this document in any form without the prior written permission of Teltonika is prohibited.

Other products and company names mentioned here may be trademarks or trade names of their respective owners.

The manufacturer reserves the right to make changes and/or improvements at any time in design, functionality, parameters and electrical characteristics without any prior notice and without incurring obligations.

1.4 About document

This document contains information about the architecture, possibilities, mechanical characteristics, and configuration of the FMB1YX device.

Acronyms and terms used in document:

FMB1YX – FMB120, FMB122 and FMB125 device;

PC – Personal Computer;

GPS – Global Positioning System;

GPRS – General Packet Radio Service;

GNSS – Global Navigation Satellite System ;

GSM – Global System for Mobile Communications;

SMS – Short Message Service;

AC/DC – Alternating Current/Direct Current;

I/O – Input/Output;

Record – AVL data stored in FMB1YX memory. AVL data contains GNSS and I/O information;

AVL packet - data packet which is being sent to the server during data transmission.

2 BASIC DESCRIPTION

FMB1YX is tracking terminal with GNSS and GSM connectivity, which is able to collect device coordinates and transfer them via GSM network to server. This device is perfectly suitable for applications, which need location acquirement of remote objects.

2.1 Package contents¹

The FMB1YX device is supplied to the customer in a cardboard box containing all the equipment that is necessary for operation. The package contains:

FMB1YX device;

Input and output power supply cable with a 2x6 connection pins;

Micro USB cable;

170mAh Li-ion rechargeable 3,7V battery;

GNSS antenna²

¹ Package content depends on Order Code, and can be customized by customer needs.

² Only for FMB122 and FMB125

2.2 Basic characteristics

GSM / GPRS / GNSS features:

- Teltonika TM2500 quad band module (GSM 850 / 900 / 1800 / 1900 MHz);
- GPRS Multi-Slot class 12 (Up to 240 kbps);
- SMS (text, data).
- Integrated GNSS receiver
- Up to -165 dBm GNSS receiver sensitivity.

Hardware features:

- Built-in movement sensor;
- Built-in Bluetooth 3.0;
- Internal High Gain GNSS antenna¹;
- Internal High Gain GSM antenna;
- microSD card reader (up to 32Gb, FAT32);
- 170 mAh Li-ion rechargeable 3.7 V battery.

Interface features for FMB120 and FMB122:

- Power supply: 10 ÷ 30V;
- 2 digital input;
- 1 analog input;
- 1 configurable input DIN3 or AIN2;
- 2 open collector digital output (connecting external relays, LED, buzzers etc.);
- 1Wire[®] temperature sensor;
- 1Wire[®] iButton;
- LVCAN RX (INPUT 5);
- LVCAN TX (INPUT 6);
- 2 LEDs indicating device status.

Interface features for FMB125:

- Power supply: 10 ÷ 30V;
- 1 digital input;
- 1 analog input;
- 1 open collector digital output (connecting external relays, LED, buzzers etc.);
- 1Wire[®] temperature sensor;
- 1Wire[®] iButton;
- LVCAN RX (INPUT 5);
- LVCAN TX (INPUT 6);
- 1 RS-232 interface;
- 1 RS-485 interface;
- 2 LEDs indicating device status.

Special features:

- Fast position fix;

¹ For FMB122 and FMB125 external GNSS antenna.

- High Quality track even in high density urban canyon;
- Ultra small case;
- Ready for harsh environment;
- Easy to mount in limited access areas;
- Firmly fasten;
- High gain external GNSS and internal GSM antennas¹;
- 2 LED status indication;
- Real-Time tracking;
- Smart data acquisition based on:
 - Time;
 - Speed;
 - Angle;
 - Distance;
 - Ignition or any other I/O event;
- Sending acquired data via GPRS;
- GPRS and SMS I/O events;
- Virtual odometer;
- Jamming detection;
- Configurable using Secured SMS Commands;
- Overvoltage protection;
- Dual SIM switching mode.

Table 1. FMB1YX Supply voltage

Description	Voltage	Duration
Normal operation	10-30V	Unlimited
Protection turns on, device turns off	34V	Unlimited
Maximum voltage	<70V	Unlimited
Maximum voltage impulse	90V	5 milliseconds

¹ Only in FMB122 and FMB125, in FMB120 internal GNSS antenna.

2.3 Technical features

Table 2. FMB1YX specification

Part name	Physical specification
Navigation LED	LED
Modem LED	LED
Socket	Soldered inner socket
USB	Micro USB socket
GNSS	Internal GNSS antenna with FMB120 External GNSS antenna with FMB122 and FMB125
GSM	Internal GSM antenna
USB	Mini USB socket

Technical details
<p>Power supply 10...30 V DC 2W Max Energy consumption¹:</p> <p>FMB120 GPRS: \overline{I} average 141.6 mA r.m.s; Nominal: average 32.11 mA r.m.s; GNSS Sleep: average 6.92 mA; Deep Sleep: average 2.46 mA . Online Deep Sleep: average 3.58. mA .</p> <p>FMB122 GPRS: \overline{I} average 151.77 mA r.m.s; Nominal: average 34.45 mA r.m.s; GNSS Sleep: average 6.67 mA; Deep Sleep: average 2.65 mA². Online Deep Sleep: average 2.95 mA³.</p> <p>FMB125 GPRS: \overline{I} average 164.59 mA r.m.s; Nominal: \overline{I} average 37.77 mA r.m.s; GNSS Sleep: \overline{I} average 11.1 mA; Deep Sleep: average 6.2 mA². Online Deep Sleep: average 6.5 mA³.</p> <p>Battery charge current: \overline{I}_{ch} average 140 mA; Operation temperature: -25 °C ... +55 °C. Storage temperature: -40 °C ... +70 °C. Storage relative humidity 5 ... 95 % (no condensation)</p> <p>Weight²:</p> <p>FMB120: 55g FMB122: 51g FMB125: 52g</p>

¹ Energy consumption has been tested at 12V voltage.

² Weight is: device, case and battery.

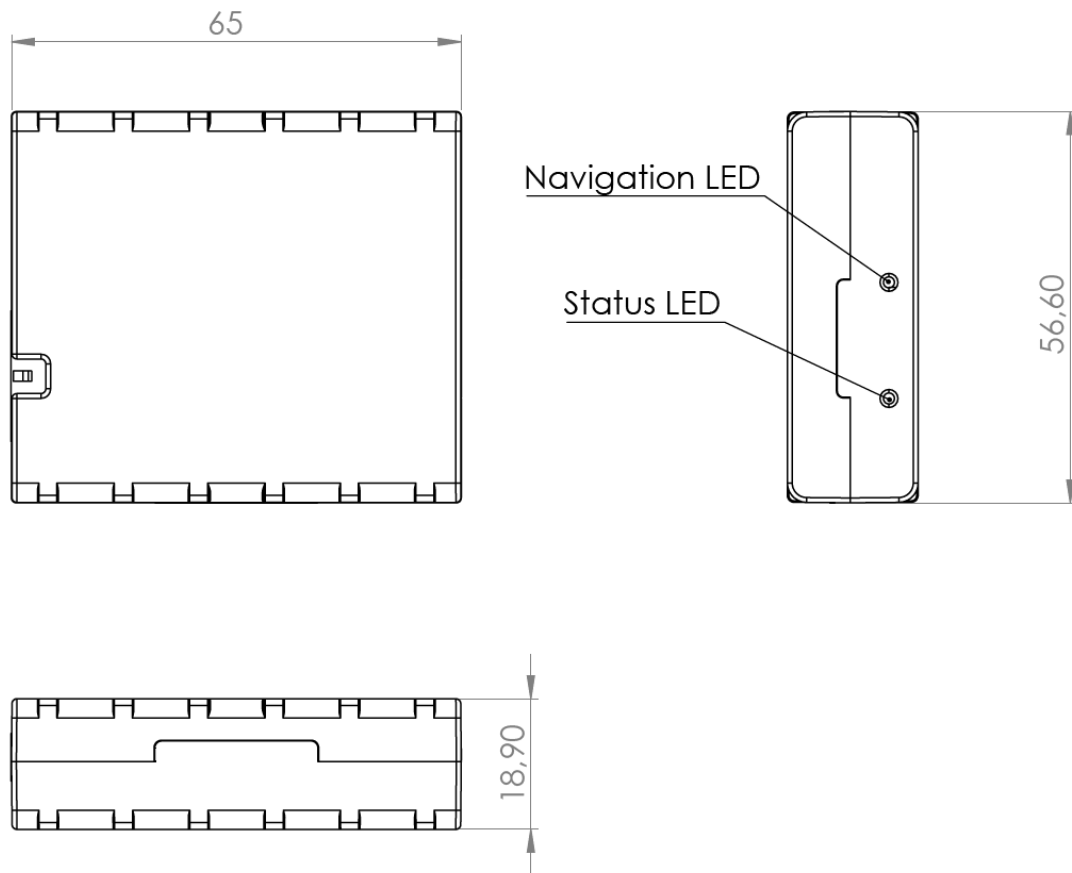

Figure 1 FMB120 view & dimensions (tolerance $\pm 2\text{mm}$)

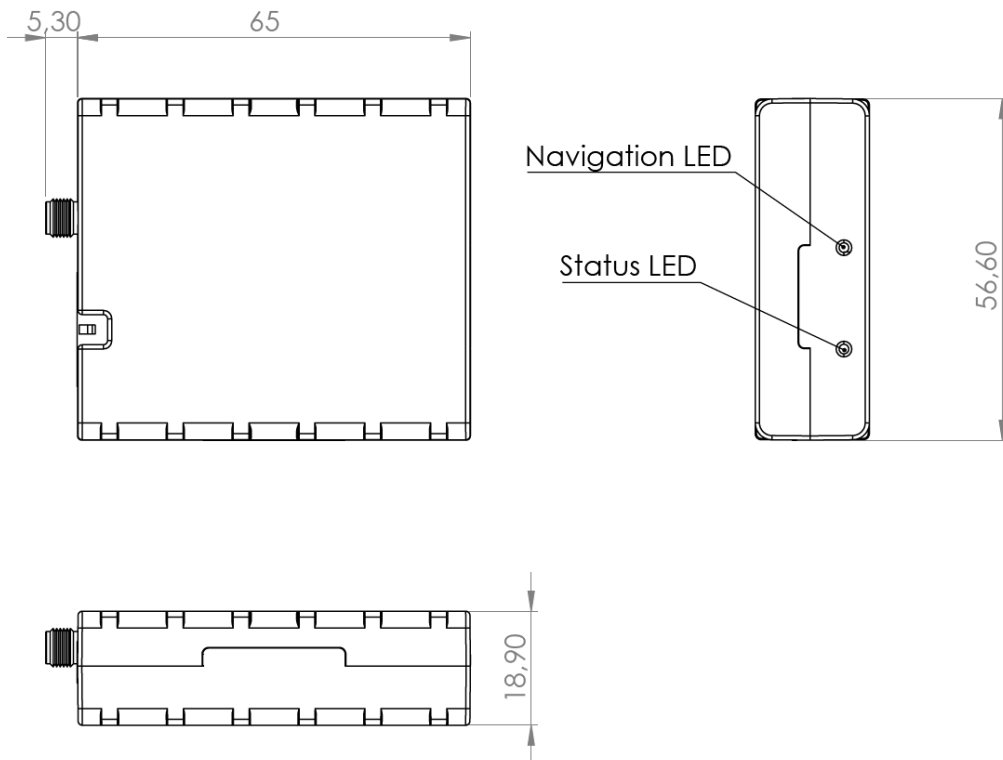

Figure 2 FMB122 and FMB125 view & dimensions (tolerance $\pm 2\text{mm}$)

2.4 Technical Information about internal battery

Table 3. Li-ion rechargeable battery, 3.7 V, 170 mAh.

Internal back-up battery	Battery voltage V	Nominal capacity (mAh)	Power(Wh)	Charging temperature °C
Li-ion rechargeable battery	3.75~3.90	170	0.64 – 0.66	0 – 45

FMB1YX internal battery is used for detecting external voltage disconnection.



CAUTION: RISK OF EXPLOSION IF BATTERY IS REPLACED BY AN INCORRECT TYPE. DISPOSE OF USED BATTERIES ACCORDING TO THE INSTRUCTIONS.

Battery Disposal instructions:



Battery should not be disposed of with general household waste. Bring damaged or worn-out batteries to your local recycling center or dispose them to battery recycle bin found in stores.

2.5 Electrical characteristics

Table 4. FMB1YX electrical characteristics

CHARACTERISTIC DESCRIPTION	VALUE			Unit
	Min.	Typ.	Max.	
Supply Voltage:				
Supply Voltage (Recommended Operating Conditions)	10		30	V
Digital Output (Open Drain grade):				
Drain current (Digital Output OFF)			120	μA
Drain current (Digital Output ON, Recommended Operating Conditions)		0.1	0.5	A
Static Drain-Source resistance (Digital Output ON)		400	600	mΩ
Digital Input:				
Input resistance (DIN1)	47			kΩ
Input resistance (DIN2)	47			kΩ
Input Voltage (Recommended Operating Conditions)	0		Supply voltage	V
Input Voltage threshold (DIN1)		7,5		V

CHARACTERISTIC DESCRIPTION	VALUE	Min.	Typ.	Max.	Unit
Input Voltage threshold (DIN2)			2,5		V
Analog Input:					
Input Voltage (Recommended Operating Conditions), Range 1		0		10	V
Input resistance, Range 1			150		kΩ
Measurement error on 12V, Range 1			0,9		%
Additional error on 12 V, Range 1			108		mV
Measurement error on 30 V, Range 1			0,33		%
Additional error on 30 V, Range 1			88		mV
Input Voltage (Recommended Operating Conditions), Range 2		0		30	V
Input resistance, Range 2			150		kΩ
Measurement error on 12V, Range 2			0,9		%
Additional error on 12 V, Range 2			108		mV
Measurement error on 30 V, Range 2			0,33		%
Additional error on 30 V, Range 2			88		mV
Output Supply Voltage 1-Wire:¹					
Supply Voltage		4,5		4,7	V
Output inner resistance			7		Ohm
Output current ($U_{out} > 3.0V$)			30		mA
Short circuit current ($U_{out} = 0$)			75		mA



Note: Analog Input error margin can increase if temperature varies.

¹ 1-wire Supply voltage PIN is dedicated for 1-wire devices ONLY, do not use it for any other purpose.

2.6 Absolute Maximum Ratings

Table 5. FMB1YX absolute maximum ratings

CHARACTERISTIC DESCRIPTION	VALUE	Min.	Typ.	Max.	Unit
Supply Voltage (Absolute Maximum Ratings)		-32		32	V
Drain-Source clamp threshold voltage (Absolute Maximum Ratings), ($I_{\text{drain}} = 2\text{mA}$)				36	V
Digital Input Voltage (Absolute Maximum Ratings)		-32		32	V
Analog Input Voltage (Absolute Maximum Ratings)		-32		32	V

3 CONNECTION, PINOUT, ACCESSORIES

3.1 How to insert SIM card into FMB1YX device¹:

① Remove FMB1YX cover

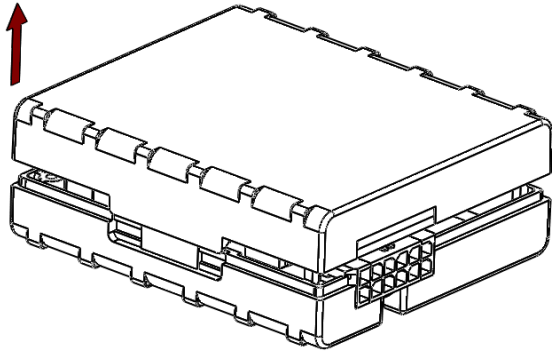

② Insert SIM cards as shown. SIM SLOT 1 is closer to PCB, SIM SLOT 2 is the upper one

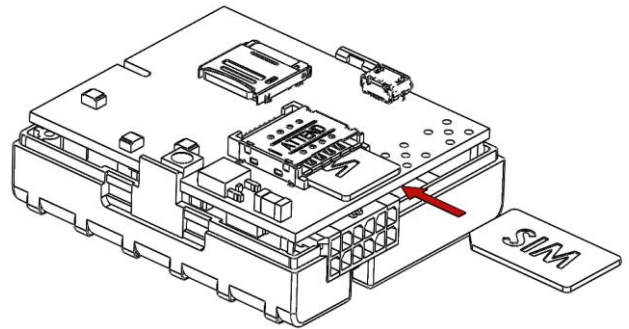

③ Attach cover

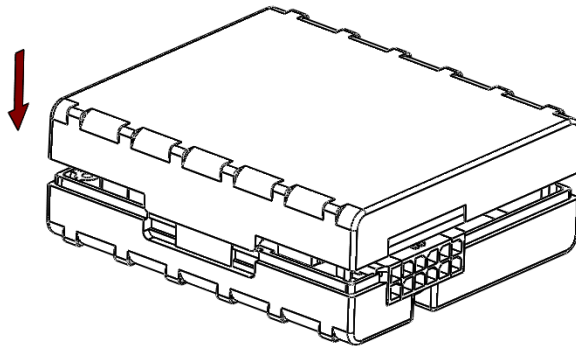

④ Device is ready

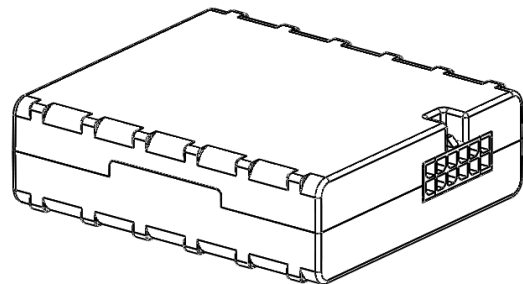

Note: SIM card insertion/removal must be performed when FMB device is powered off – external voltage and battery disconnected. Otherwise SIM card might be damaged or FMB device will not detect it.

¹ In pictures are FMB120 device

3.2 How to add MicroSD card into FMB1YX device

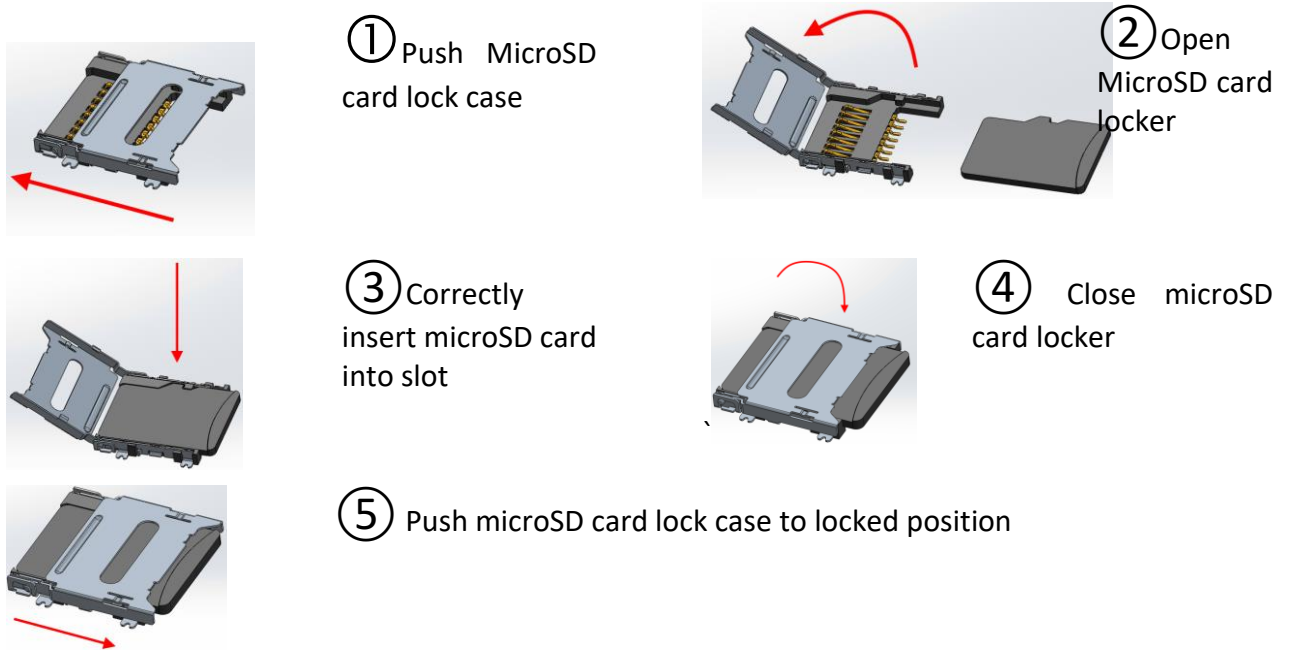

3.3 Installing FMB1YX drivers

Table 6. Software requirements:

Operating system (OS)	Version	MS .NET Framework version
Windows XP with SP3 or later	32 bit and 64 bit	MS .NET Framework 4 https://www.microsoft.com/en-US/Download/confirmation.aspx?id=17718 http://avl1.teltonika.it/downloads/software/Framework/.NET%20Framework%204/dotNetFx40_Full_x86_x64.exe
	32 bit 64 bit	With MS .NET Framework 4 update KB2468871-v2 update https://www.microsoft.com/en-us/download/details.aspx?id=3556 http://avl1.teltonika.it/downloads/software/Framework/.NET%20Framework%204%20update%20KB2468871-v2/ NDP40-KB2468871-v2-x86.exe NDP40-KB2468871-v2-x64.exe or NDP40-KB2468871-v2-IA64.exe
Windows Vista Windows 7 Windows 8.1 Windows 10	32 bit and 64 bit	MS .NET Framework 4.6.2 https://www.microsoft.com/en-us/download/confirmation.aspx?id=53344 http://avl1.teltonika.it/downloads/software/Framework/.NET%20Framework%204.6.2/NDP462-KB3151800-x86-x64-AllOS-ENU.exe

Drivers:

Please download COM Port drivers from Teltonika website:

http://avl1.teltonika.it/downloads/FMB1/MS_USB_ComPort_Driver_exe_v1.1032.3.zip

Installing drivers:

Extract and run MS_USB_ComPort_Driver_exe_v1.1032.3. This driver is used to detect FMB1YX device connected to the computer. Click 'Next' in driver installation window (figures below):

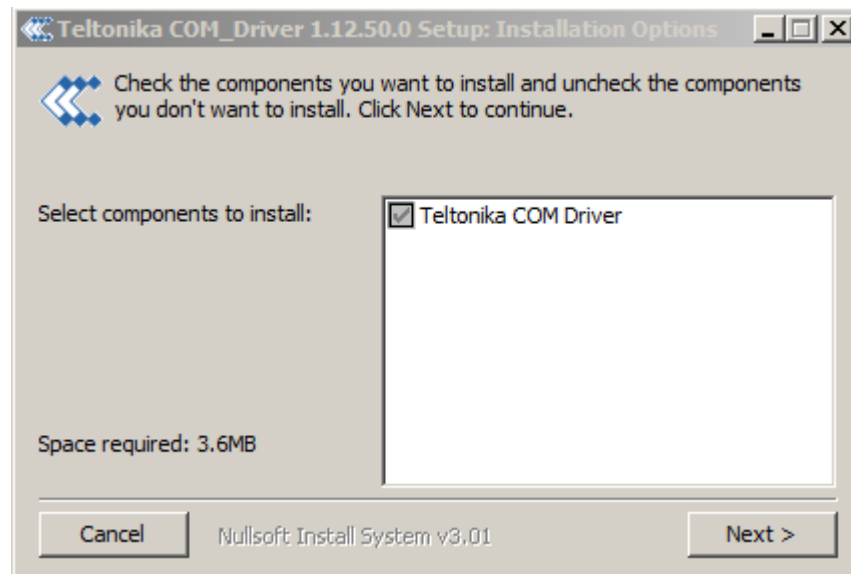

Figure 3 Driver installation window

This will launch device driver installation wizard. In the following window click 'Install' button:

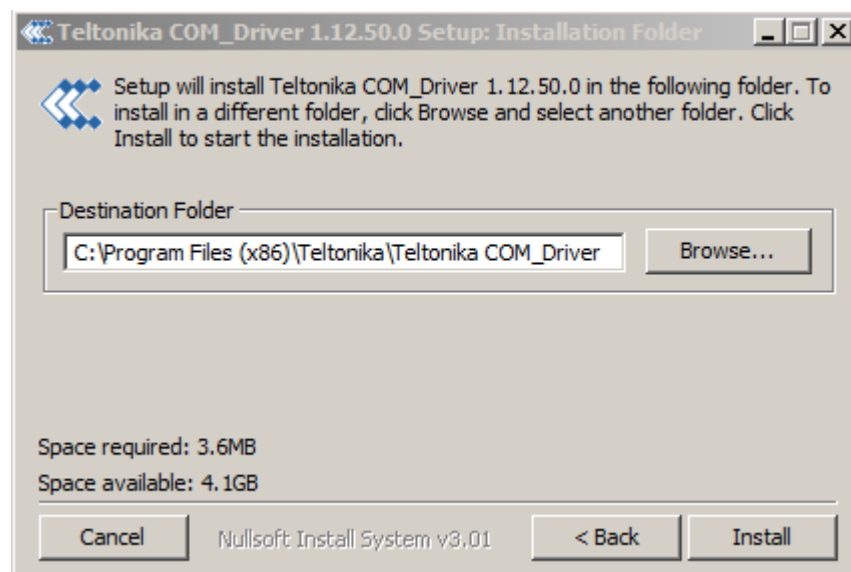

Figure 4 Driver installation window

Setup will continue installing drivers and will display a window about successful process at the end. Click 'Finish' to complete setup:

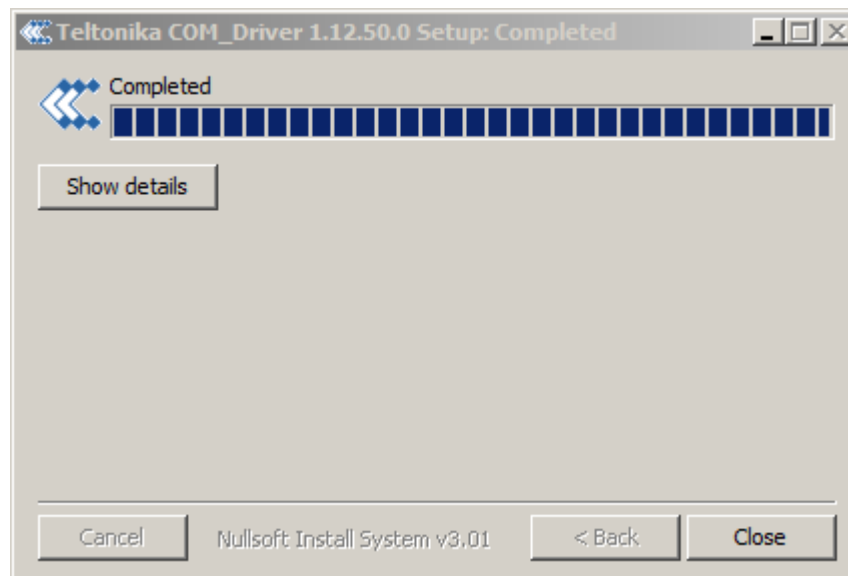

Figure 5 Driver installation window

You have now installed drivers for FMB1YX device successfully.

3.4 FMB120 and FMB122 2x6 socket pinout

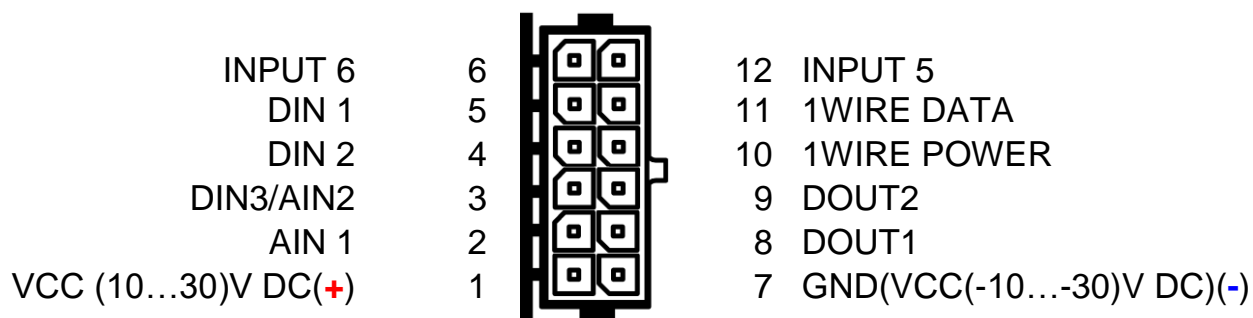

Figure 6 FMB120 and FMB122 2x6 socket pinout

Table 7. FMB120/FMB122 pinout description

Pin Nr.	Pin Name	Description
1	VCC (10÷30)V DC (+)	Power supply for module. Power supply range (10...30) V DC (+)
2	AIN 1	Analog input, channel 1. Input range: 0-30V DC
3	AIN 2 / DIN 3	Analog input, channel 2. Input range: 0-30V DC / Digital input, channel 3.
4	DIN 2	Digital input, channel 2.
5	DIN 1	Digital input, channel 1.
6	INPUT 6	TX EXT (LVCAN – TX)
7	GND(VCC(10÷30)V DC)(-)	Ground pin. (10÷30)V DC (–)
8	OUT 1	Digital output, channel 1. Open collector output. Max. \overline{I} 3,3 A.
9	OUT 2	Digital output, channel 2. Open collector output. Max. \overline{I} 3,3 A.
10	1WIRE POWER	+3,8 V output for 1 – Wire devices
11	1WIRE DATA	Data channel for 1 – Wire devices

12	INPUT 5	RX EXT (LV CAN - RX)
----	---------	----------------------

3.5 FMB125 2x6 socket pinout

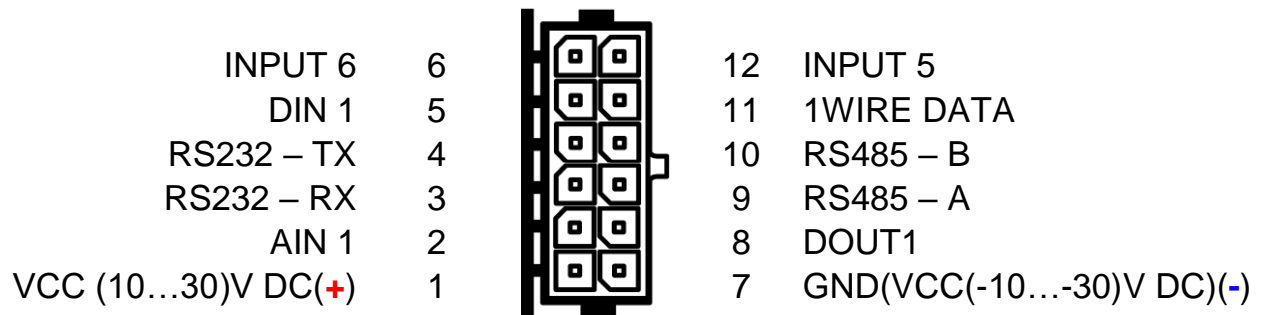

Figure 7 FMB125 2x6 socket pinout

Table 8. FMB125 pinout description

Pin Nr.	Pin Name	Description
1	VCC (10÷30)V DC (+)	Power supply for module. Power supply range (10...30) V DC (+)
2	AIN 1	Analog input, channel 1. Input range: 0-30V DC
3	RS232 – RX	Input for data receive through RS232
4	RS232 – TX	Output for data transmit through RS232
5	DIN 1	Digital input, channel 1.
6	INPUT 6	RX EXT (LV CAN – RX)
7	GND(VCC(10÷30)V DC)(-)	Ground pin. (10÷30)V DC (—)
8	OUT 1	Digital output, channel 1. Open collector output. Max. --- 3,3 A.
9	RS485 – A	Signal A wire for RS485
10	RS485 – B	Signal B wire for RS485
11	1WIRE DATA	Data channel for 1 – Wire devices
12	INPUT 5	TX EXT (LV CAN - TX)

3.6 Accessories



Note: Accessories are not included in device package, please order them separately.

Table 9. FMB1YX accessories description and connection schemes

Accessories Description	Accessories connection schemes																					
1 – Wire devices	Digital thermometer DS1820 and TTJ100 connection scheme with FMB120 and FMB122																					
One of the realized features FMB1YX is 1-Wire® data protocol, which enables connection of thermometer (DS1820, DS18S20 and DS18B20) and I-Button type: DS1990A .																						
	<table border="1" style="width: 100%; border-collapse: collapse;"> <tr> <td style="width: 30%; text-align: center;">Left row of pins</td> <td style="width: 40%;"></td> <td style="width: 30%; text-align: center;">Right row of pins</td> </tr> <tr> <td style="text-align: center;">1W. PWR (FMB1YX – pin10)</td> <td style="text-align: center;">1</td> <td></td> </tr> <tr> <td style="text-align: center;">1W. Data (FMB1YX – pin11)</td> <td style="text-align: center;">2</td> <td></td> </tr> <tr> <td style="text-align: center;">GND (FMB1YX – pin7)</td> <td style="text-align: center;">3</td> <td></td> </tr> <tr> <td style="text-align: center;">Digital Input</td> <td style="text-align: center;">4</td> <td></td> </tr> </table> <div style="text-align: center; margin: 10px 0;"> </div> <table border="1" style="width: 100%; border-collapse: collapse;"> <tr> <td style="width: 30%;"></td> <td style="width: 40%;"></td> <td style="width: 30%; text-align: center;"> Vpp (+5 Volts DC) – power source for external digital sensor 1 </td> </tr> <tr> <td></td> <td></td> <td style="text-align: center;"> Output from external digital sensor 2 </td> </tr> </table>	Left row of pins		Right row of pins	1W. PWR (FMB1YX – pin10)	1		1W. Data (FMB1YX – pin11)	2		GND (FMB1YX – pin7)	3		Digital Input	4				Vpp (+5 Volts DC) – power source for external digital sensor 1			Output from external digital sensor 2
	Left row of pins		Right row of pins																			
1W. PWR (FMB1YX – pin10)	1																					
1W. Data (FMB1YX – pin11)	2																					
GND (FMB1YX – pin7)	3																					
Digital Input	4																					
		Vpp (+5 Volts DC) – power source for external digital sensor 1																				
		Output from external digital sensor 2																				
Digital thermometer DS1820 connection scheme with FMB125																						

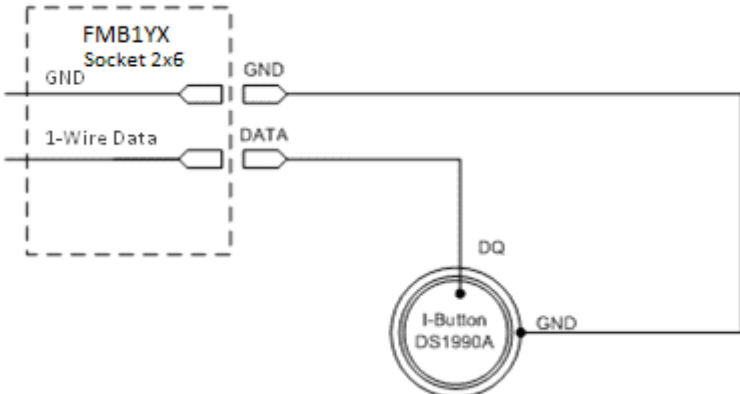
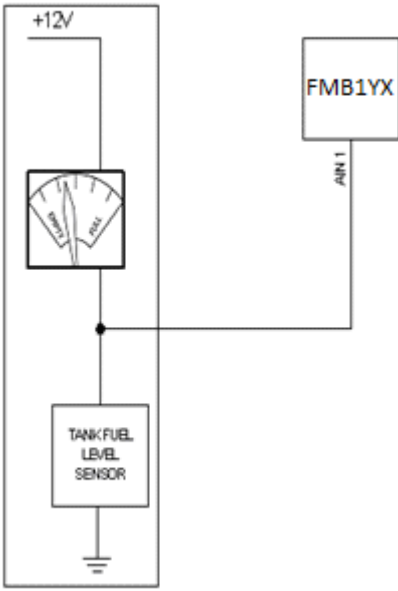
Accessories Description	Accessories connection schemes
	<p data-bbox="762 315 1257 344" style="text-align: center;">I-Button DS1990A connection scheme</p>  <p>The diagram shows an FMB1YX Socket 2x6 on the left with terminals for GND and 1-Wire Data. On the right, there are terminals for GND and DATA. A wire connects the GND terminal of the socket to the GND terminal of the I-Button DS1990A. Another wire connects the 1-Wire Data terminal of the socket to the DATA terminal of the I-Button DS1990A. The I-Button DS1990A is shown as a circular component with a DQ pin and a GND pin.</p>
<p data-bbox="204 790 448 819">Fuel Tank sensors</p> <p data-bbox="204 831 512 1715">A fuel tank level sensor exists in most cars, which shows the approximate fuel level in the driver's indicator panel. It is possible to connect FMB1YX Analog input to it (if sensor returns analogue signal proportional to fuel level). After the connection to the tank fuel level sensor, calibration is needed. Calibration is needed because most fuel tank sensors are not linear. Calibration is performed by measuring voltage dependence on volume of fuel in tank.</p>	<p data-bbox="879 790 1139 819" style="text-align: center;">Fuel sensor scheme</p>  <p>The diagram shows a +12V power source connected to a fuel gauge. The gauge is labeled with 'FULL' and 'RES.' (Reserve). Below the gauge is a 'TANK FUEL LEVEL SENSOR' connected to ground. An FMB1YX module is connected to the gauge's signal line at a point between the gauge and the sensor. The FMB1YX module has a terminal labeled 'AN 1'.</p>
<p data-bbox="204 1731 480 1794">Alarm buttons, door sensors, etc.</p>	<p data-bbox="847 1742 1171 1771" style="text-align: center;">Panic button connection</p>

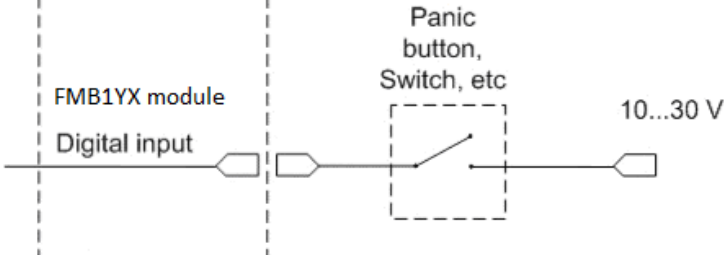
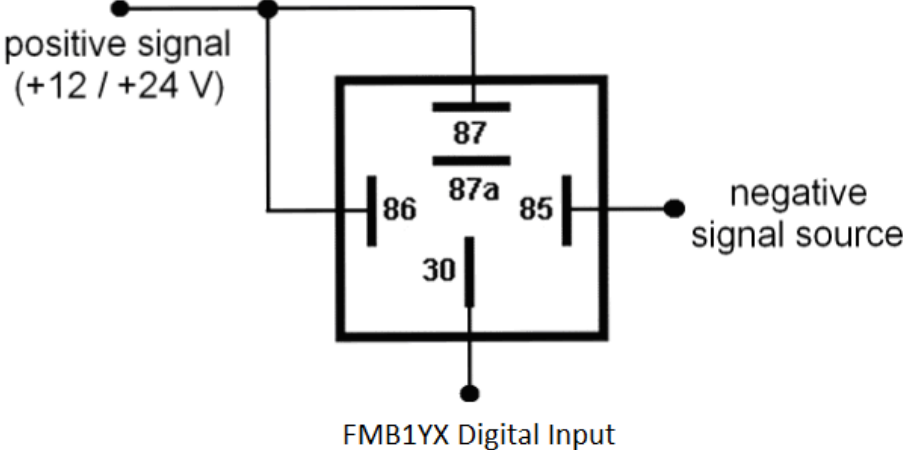
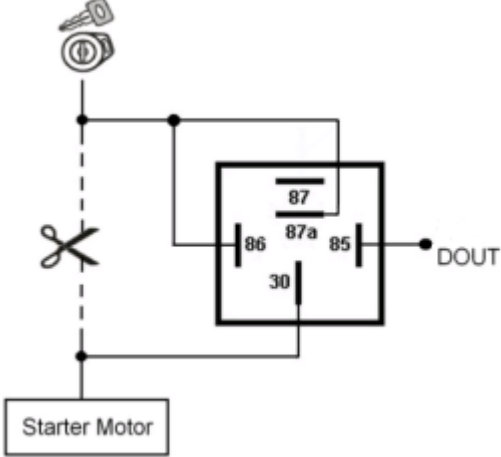
Accessories Description	Accessories connection schemes
<p>Alarm buttons, door sensors, ignition, etc. return two states: high or low voltage. FMB1YX Digital inputs are used to read this information.</p>	
<p>In cases when sensor FMB1YX output signal is negative, an additional relay has to be installed to convert negative signal to positive.</p>	<p style="text-align: center;">Inverting relay connection</p> 
<p>Immobilizer relay</p> <p>When connected as shown below, FMB1YX disables engine starter when output is ON. More details about relays can be found below.</p>	<p style="text-align: center;">Immobilizer relay connection</p> 
<p>Relays</p>	<p style="text-align: center;">Automotive relay pinout</p>

Accessories Description	Accessories connection schemes
<p>An ordinary automotive relay is used to invert input signal or to immobilize engine starter. Note, that they are available as 12 V or 24 V.</p>	

3.7 *Navigate LED*

Table 10. FMB1YX navigation LED description

Behavior	Meaning
Permanently switched on	GNSS signal is not received
Blinking every second	Normal mode, GNSS is working
Off	GNSS is turned off because: Device is not working Or Sleep mode
Blinking fast constantly	Device firmware being flashed

3.8 *Status LED*

Table 11. FMB1YX status LED description

Behavior	Meaning
Blinking every second	Normal mode
Blinking every 2 seconds	Sleep mode
Blinking fast for a short time	Modem activity
Off	Device is not working Or Boot mode

4 OPERATIONAL BASICS

4.1 *Operational principals*

FMB1YX module is designed to acquire records and send them to the server. Records contain GNSS data and I/O information. Module uses GNSS receiver to acquire GNSS data and is powered with three data acquiring methods: time-based, distance-based and angle-based. Note, that if FMB1YX loses connection to GNSS satellites, it continues to make records, however

coordinate in these records remains the same (last known coordinate). All data is stored in flash memory and later can be sent via GPRS.

GPRS and SMS settings are described in later sections. FMB1YX communicates with server using special data protocol.

FMB1YX can be managed by SMS commands. SMS Command list is described in SMS/GPRS COMMAND LIST section. Module configuration can be performed only via SMS.

4.2 Sleep modes

There are three sleep modes: GPS sleep, Deep sleep and Online sleep mode.

4.2.1 GPS Sleep mode

FMB1YX is able to go to GPS sleep mode if such mode is enabled.

Sleep mode timeout (defined period in minutes) starts counting when device is in STOP mode. After timeout is reached and all conditions for GPS sleep mode are met, device goes to sleep mode. While in GPS sleep mode, FMB1YX turns GPS module off and it is still making new periodic records. As a result power usage decreases, in turn saving vehicle battery.

FMB1YX can enter GPS sleep mode if **ALL** of these conditions are met:

- FMB1YX has to be configured to work in GPS Sleep mode and start sleep timeout is reached;
- Device must be synchronized time with GNSS satellites and have GPS fix;
- No movement by configured movement source or movement sensor is detected;
- Ignition (configured Ignition Source) is off.
- Forced wakeup is not set;
- Have no SMS to read;

FMB1YX exits GPS sleep mode when if **ONE** of following conditions are true:

- Movement by movement source or movement sensor is detected;
- Ignition (configured Ignition Source) is turned on.

4.2.2 Deep Sleep mode

While in deep sleep mode, FMB1YX sets GNSS receiver to sleep mode and turns off GSM/GPRS module (it is not possible to wake up device via SMS). Despite records with last known coordinate are being saved and send to AVL server (GSM/GPRS module is turned on to send data and after that it is turned off again), power usage is decreased to save vehicle's battery. Note, that power saving depends on two configurable parameters: send period and min. record saving period in "X on Stop Mode". When records are sendet in deep sleep mode, after successful records sending open link timeout counter will be sciped and FMB1YX will enter deep sleep mode immediately.

Because a lot off functions are disabled in deep sleep mode 13 I/O elements are disabled from records that are generated in this mode: GSM Signal, GNSS Status, GNSS PDOP, GNSS HDOP, Speed, GSM CellID, GSM Area Code, Fuel rate GPS, Active GSM Operator, Trip Odometer, Total Odometer, Fuel Used GPS and ICCID.

FMB1YX can enter deep sleep mode if **ALL** of these conditions are met:

- FMB1YX has to be configured in Deep Sleep Mode and Sleep timeout is reached
- Device must be synchronized time with GNSS satellites and have GPS fix;

- Ignition (configured Ignition Source) is off.
- Movement by accelerometer or configured movement source is not detected;
- Min. Record Saving Period (Data Acquisition Mode settings) must be bigger than Open Link Timeout parameter, that FMB1YX could close GPRS link.
- Send period (Data Acquisition Mode settings) minus Open Link Timeout must be more than 90 sec., that FMB1YX could close GPRS link for at least 90 sec.
- Forced wakeup is not set;
- Have no SMS to read;
- Data socket(s) are close;
- Data sending is not in progress;
- FOTA is not in progress;

FMB1YX exits deep sleep mode when if **ONE** of following conditions are true:

- Movement by accelerometer or configured movement source is detected;
- Ignition (configured Ignition Source) is turned on.

4.2.3 Online Deep Sleep mode

In this mode device works as in Deep Sleep mode, but without deregistering from GSM network. GSM part stays powered, so this increases power consumption. In this mode, device should receive/send SMS and make/receive calls. Also not closes GPRS context, if previously opened.

Conditions to enter Online Sleep mode is the same as entering Deep Sleep mode.

FMB1YX exits Online Sleep mode when if **ONE** of following conditions are true:

- Movement by accelerometer or configured movement source is detected;
- Ignition (configured Ignition Source) is turned on.

4.3 Virtual odometer

Virtual odometer is used to calculate traveled distance in FMB1YX as separate I/O elements. When FMB1YX detects movement, it starts counting distance using GNSS signal: every second it checks current location and calculates distance between current and previous point. It keeps adding these intervals until it is time to make a record, then FMB1YX records its location and adds odometer value, which is equal to the sum of all distances, measured every second. There are two odometers I/O elements: Total odometer and Trip odometer.

Total odometer counts all distance traveled by vehicle. After device restart the value in this I/O element will not be erased. Total odometer value can be changed by SMS command "odomet" (SMS Command list is described in SMS/GPRS COMMAND LIST section).

Trip odometer is Trip scenario element and it can be selected from two modes: Continuous and Between Records. Both modes requires ignition (configured ignition source) to be turned on.

When Between Records mode is selected, when record is made, odometer resets to zero and distance calculation starts all over again.

When Continuous odometer mode is selected, all distance calculations is counted from records and sums them to one distance. Continuous odometer stops counting, when vehicle is at stop and ignition is turned off.

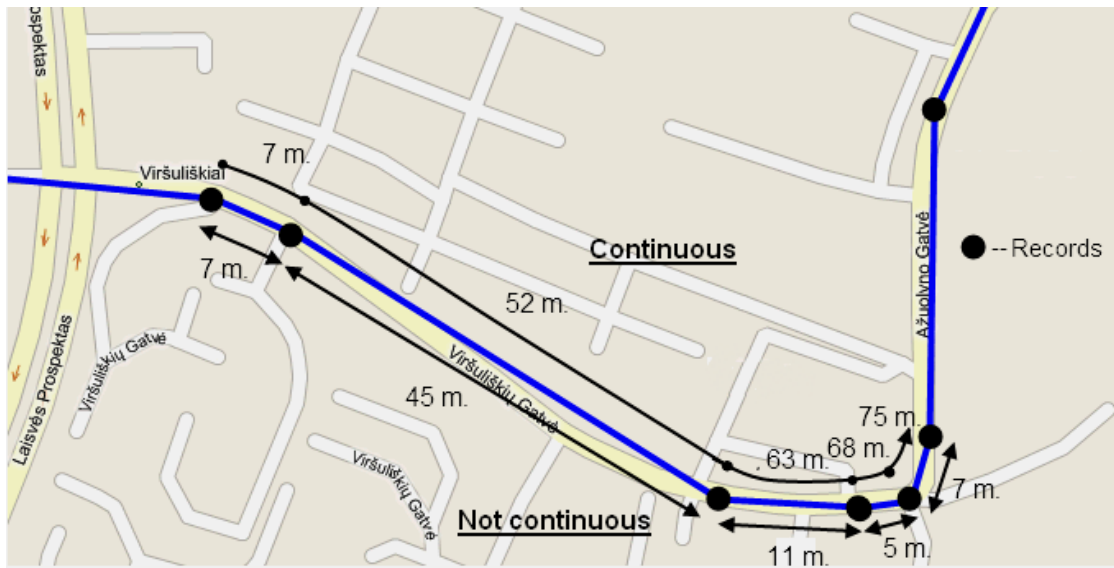

Figure 8 Odometer continuous and Not continuous distance counting parameter example

4.4 Features

Using available features can greatly increase FMB1YX usability options.

4.4.1 ECO driving/Green driving Scenarios



ECO driving/Green driving Scenarios. Helps to prevent and inspect driver about harsh driving. Eco driving scenario continuously monitors: accelerating, braking and cornering forces depending on build in accelerometer or Green driving depending on GPS. The device inspects driver if needed. Monitoring sensitivity is configurable.

Digital output can be controlled by scenario for user needs, buzzer or LED for example. Output activation time after harsh event is also configurable.

To save GPRS traffic ECO driving/Green driving event will be **generated (included into records) only** when FMB1YX measured values are higher than those set in configuration, without additional I/O settings.

To prevent generating false events, harsh acceleration and harsh braking is monitored only when following conditions are fulfilled:

- Ignition is ON (configured Ignition Source)
- Vehicle speed is equal or higher than 10km/h

Harsh cornering is monitored only when following conditions are fulfilled:

- Ignition is ON (configured Ignition Source)
- Vehicle speed is equal or higher than 30km/h

ECO driving or Green driving Scenario? Eco driving is based on accelerometer value and Green driving based on GPS position.



PLEASE NOTE that Eco Driving functionality generally is dependent on accelerometer. Auto calibration must be done before using ECO driving scenario. All information about auto calibration described in [5.9.1.2 chapter](#).

4.4.2 OverSpeeding Scenario.

Helps to prevent from exceeding fixed speed and inspects driver if needed. Digital output can be controlled by scenario for user needs, to manage buzzer, LED, etc.

4.4.3 Jamming detection

Jamming detection shows when GSM signal jamming occurs. Digital output can be controlled by scenario for user needs, to manage buzzer, LED, etc.

4.4.4 Trip

Trip customizable feature enables user extended monitoring of performed trips (from engine start at present location to engine stop at arrived location), log their start and stop points, view driven total distance¹ and calculate eco score value.

Odometer calculation source can be selected between GNSS, OBD or LVCAN.



Note: Scenarios and Trip feature are activated (DOUTs are activated) only if ignition is on.

4.4.5 DOUT Control Via Call

Activates DOUT on incoming call



Note: in Excessive Idling, Jamming and Trip scenarios if Eventual Records is enabled Event will be **generated (included into send records) only** when scenario starts and finishes. If Eventual Records is disabled scenario status value is sent in each AVL record.

4.4.6 Immobilizer

Immobilizer Scenario. Vehicle can be used only if iButton is connected. If iButton List Check is enabled gives ability to use vehicle only for 500 specific iButton owners (specified in iButton list). If iButton List Check is disabled connect any iButton to pass Immobilizer security. Digital output can be controlled by scenario for user needs, to manage buzzer, LED, etc.

¹ Continuous trip odometer – total driven distance, works only in TRIP mode. Continues distance is counted only for ONE trip. If trip is finished (stop point is detected), odometer resets to 0 (zero). Next trip will start counting from the beginning. Between Records trip odometer – another odometer that are used only in TRIP mode. In this mode distance will be counted until any record is made, then odometer will be reseted to zero and started counting to next record again.

4.4.7 iButton read notification

This functionality allows user to see when iButton is being readed. Selected DOUT turns on for configured duration.

4.4.8 GPS Fuel Counter

This functionality is meant to calculate fuel consumption based on set consumption values in different situations.

4.5 Accelerometer Features

4.5.1 Excessive Idling

Informs you if your vehicle is stationary but engine is on for selected period of time to help you to save fuel.

4.5.2 Unplug Detection

Unplug detection scenario generates event when FMB1YX is unplugged from external power and plugged into external power.

4.5.3 Towing Detection

Towing detection feature helps to inform driver about car departing. FMB1YX generates event when car is being towed or lifted, for example in case of vehicle evacuation.

4.5.4 Crash Detection

If Crash detection is enabled, it monitors acceleration on each axis, which helps to detect an accident.

If Crash trace is disabled crash detection event will be generated (included into send record) only when scenario starts and finishes.

If Crash trace is enabled FMB1YX will collect acceleration data every 40 msec. Buffer is big enough to hold data for 5 seconds and on Crash Event detection, records will be generated from this buffer, following these conditions:

- Every second Acceleration changed more then $> 50\text{mG}$ Data will be collected and records generated 5 seconds after the event using the same conditions.
- Every generated record will have accelerometer X Y Z values included.
- Each record will have accurate timestamps in milliseconds.



Note: in Unplug Detection and Towing Detection scenarios if Eventual Records is enabled Event will be **generated (included into send records) only** when scenario starts and finishes. If Eventual Records is disabled scenario status value is sent in each AVL record.

4.6 Bluetooth

Bluetooth can work in two modes - *slave* or *master*.

While working as *master* mode - Bluetooth can connect to defined "*hands free*" or "*OBDII*" system.

While working as *slave* mode - Bluetooth can accept incoming connection from external device.



NOTE: FMB1YX supports ONE connection at a time.

4.7 Auto Geofence

Auto Geofencing feature if enabled is activated automatically by turning off car ignition. Next time before driving user has to disable Auto Geofencing with iButton, digital input, by external voltage or by car Engine RPM. In case of theft car leaves Auto Geofencing zone without authorization FMB1YX device automatically sends record to AVL application and SMS (if configured).

4.8 Manual Geofence

Geofencing is another feature which is highly customizable and can detect wherever car enters or leaves customized areas. More about Geofencing can be read in [5.13](#) chapter.

4.9 iButton list

iButton list is used to enter authorized iButton ID codes, which are used to authenticate driver in Authorized driving and Auto Geofencing options.

5 CONFIGURATION

5.1 Configurator

FMB1YX module has default factory settings. Settings should be changed according to your application and your GSM operator information.

FMB1YX configuration may be performed via SMS commands or configurator.

FMB1YX has one user editable profile.

It can be configured to acquire and send data to server. If device is not able to send data to server, GSM is not available FMB1YX will start storing records to flash memory. It is possible to store up to 192 000 data records with 128 Mb SD memory card (when 100 Mb are used for store records). It will send data later when GPRS is available again. Note that FMB1YX can have memory full of records. In such case it will start deleting oldest records in order to save new ones. Sending all data records to server may take some time.

FMB1YX configuration is performed via FMB1YX Configurator program. Contact sales manager to get the latest FMB1YX Configurator version. FMB1YX configurator operates on Microsoft Windows OS and uses MS .NET Framework. For Windows XP you will need MS .NET Framework 4 (with MS .NET Framework 4 update KB2468871-v2) for Windows Vista, Windows 7, Windows 8.1, Windows 10 MS .NET Framework 4.6.2 or later. Please ensure that suitable MS .NET Framework version for your OS is installed on your PC before starting configurator. Latest MS .Net Framework version can be downloaded from official Microsoft web page.

Module configuration is performed over USB cable or Bluetooth port. Configuration process starts from starting FMB1YX Configurator program and then connecting to FMB1YX

device via Connect button located in Online menu part. FMB1YX has one user editable profile, which can be loaded from device, and saved. User can also revert to default settings, by pressing Reset to defaults button. After any modification of configuration settings it has to be saved to FMB1YX device, otherwise it will not be written to device.



Figure 9 FMB1YX configurator window when selecting the connection method

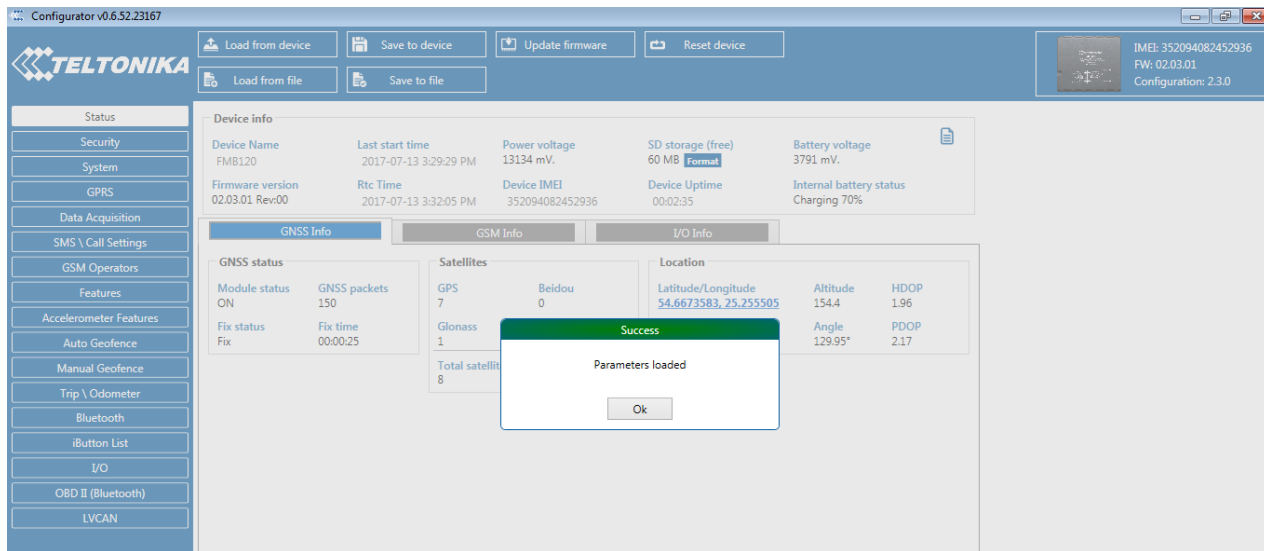

Figure 10 FMB1YX configurator main window when connected to it and successfully loaded parameters

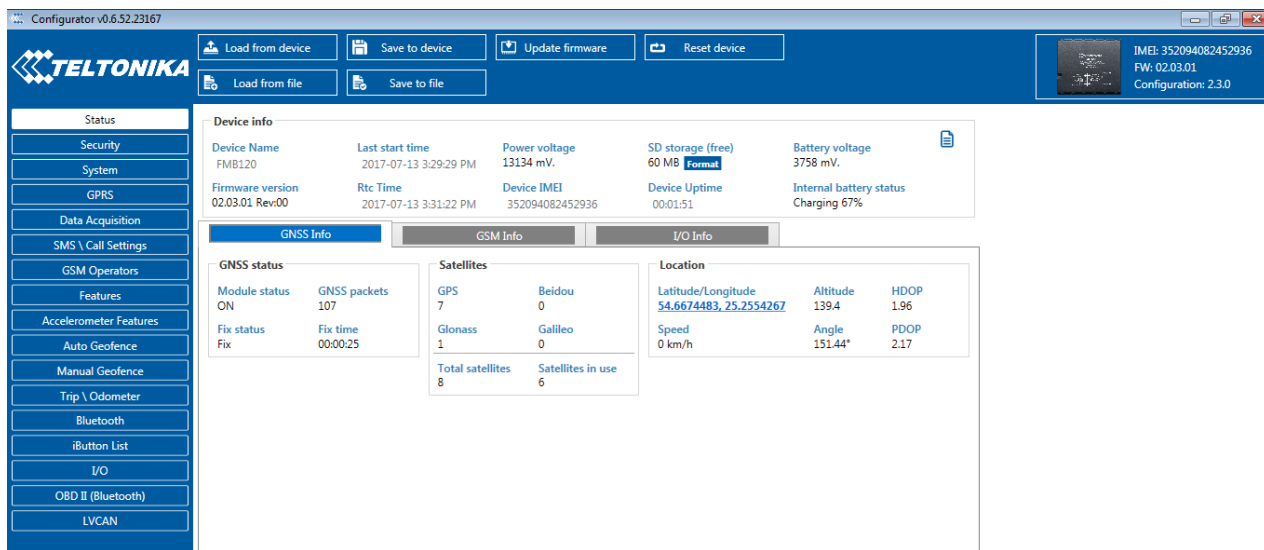

Figure 11 FMB1YX configurator status column

5.1.1 Main Buttons description:

- 'Connect to device' (Figure 9) – connects device.
- 'Load from device' – loads configuration from device.
- 'Save to device' – save configuration to device.
- 'Load from file' – load configuration from file.
- 'Save to file' – save configuration to file.
- 'Update firmware' – update firmware on device.
- 'Reset device' – reset device configuration to default.

5.1.2 Keyword SMS (GPRS) commands:

"setkey <oldkeyword> <newkeyword>" - Set new or change the keyword. Configuration should be not locked. Example:

New keyword (set):

```
<name>{space}<pass>{space}setkey{space}{space}<newkeyword>
```

Change keyword (change):

```
<name>{space}<pass>{space}setkey{space}<oldkeyword>{space}<newkeyword>
```

"delkey <keyword>" - Deletes current keyword. Configuration keyword should be configured and not locked.

Example:

```
<name>{space}<pass>{space}delkey{space}<keyword>
```

5.1.3 Keyword configuration with TCP

If configuration has keyword, it will be saved to configuration file.

After TCP configuration: if keyword in configuration file does not match keyword in device, configurator will ask which keyword must be used for device.

If device is locked, keyword cannot be changed with TCP configuration.

5.2 Status info

Status info monitoring FMB1YX real time information in 5 different positions: Device info, GNSS info, GSM info, OBD/ CAN adapter info and I/O info. All this information can be saved into .HTML format with a button which is in device info table top right corner.

In device info user can see device name, firmware version, last device start time, RTC Time, power voltage (mV), device IMEI, SD card free space, Device uptime, Battery voltage (mV) and internal battery status.

In GNSS info user can see:

- Real time GNSS status information: module status (ON, deep/GPS/Online sleep mode), how much GNSS packets device got from startup, what is fix status and what was last GNSS fix time.
- Satellites information: how many and what type of satellites are visible. How many satellites are used for location positioning.
- Location information: latitude, longitude, altitude, angle, HDOP, PDOP and speed.

In GSM Info user can see:

- GSM status: modem status, SIM status, GPRS status, actual operator code and GSM signal level.
- GPRS traffic: how much data has been send from device and received from device.
- Sockets information: what server domain and port is used.
- Records: how much records were sent to server from last data reset, when last record send to server was and when was last server response.
- SMS count: how much FMB1YX received SMS and how much SMS was send from device.

In OBD info user can see main information from OBD (if device connected to vehicle with OBD II Bluetooth dongle adapter): vehicle VIN code and used OBD protocol.

In CAN Adapter info user can see main information from LV-CAN200/ ALL-CAN300 (if device connected to LV-CAN200/ ALL-CAN300): program number and LV-CAN200/ ALL-CAN300 SW version

In I/O info user can see all I/O element values from all configurable I/O elements.

5.3 Security info

In security section user can see SIM card and configurator keyword security information.

- User can see SIM1 and SIM2 state and now connected to device SIM card current status. If used SIM card with PIN code user can enter it here. How much attempts left to enter pin code is showed to.
- When SIM PIN code is entered correctly user can change PIN code or disable it from SIM card. When SIM PIN is disabled and user what to enable it again user must enter last used PIN code.
- If into device are inserted two SIM cards, user can change PIN code to both of them.
- For configuration security keyword can be set to configurator. Keyword can be saved in configuration file (.cfg), so there is no need to connect the device to the configurator to configure keyword. Min keyword length is 4 symbols and max length is 10 symbols. Only uppercase and lowercase letters and numbers are supported. Keyword can be configured to .cfg configuration file when device is not connected to device.

5.4 System settings

System settings have 9 configurable parameters:

- Sleep settings, where user can choose sleep mode;
- Ignition source, where user can choose between power voltage, digital input 1, accelerometer and engine RPM as ignition sources. More than one ignition source can be selected at the same moment. User can select movement start and movement stop delay time (in seconds): those parameters are used when ignition source is accelerometer. Into ignition status take the following functionalities: power manager, eco driving, excessive idling, fuel consumption, over speeding, towing and trip functionalities.
- Object Motion Detection Settings, where user can configure 4 ways how FMB1YX will detect stopped movement, and change its working mode (for working modes, read section 5.8). Other functionalities that depend from movement source: power manager, fuel consumption and trip.

- Static navigation settings, where user can turn static navigation on or off. Additional, user can chose from what source (movement or ignition) static navigation can be deactivated/activated;
- Records Settings, where user can enable or disable records when GPS is not available (no time synchronization);
- GNSS source Settings, where user can choose satellite system.
- LED indication, where user can turn on or off indication leds.
- Battery charge mode, where user can choose when battery will be charged: on need (battery will be charged anytime when it need to be charged) and after ignition ON (battery will be charged only when ignition is on).
- Analog Input value range, where user can choose analog input range 10 V or 30 V (10 V range for now works same as 30 V range).
- Time synchronization settings, where user can choose from what source (or sources) FMB1YX time will be synchronized. User has choice to use only one synchronization source by GNSS. When selected synchronization from NTP, time will be synchronized from NTP server and from GNSS. When selected synchronization from NITZ, time will be synchronized from GSM operator and GNSS. When selected synchronization from NITZ+NTP, time will be synchronized from all three sources (if it is necessary). Every time GNSS fix will be acquired time will be synchronizes (if needed). User can select from what NTP server (possible to configure two servers) time will be synchronized and what time period (in hours) is used to resynchronize time.

Table 12. Object Motion Detection Settings

Movement Source	Vehicle on Stop mode	Vehicle Moving mode
Ignition (recommended)	If ignition (ignition source) is logic low	If ignition (ignition source) is logic high
Movement (movement sensor)	Internal movement sensor does not detect movement	Internal movement sensor detects movement
Movement Source	Vehicle on Stop mode	Vehicle Moving mode
GPS	GPS fix is available and vehicle speed is lower than 5 km/h	GPS fix is available and vehicle speed is higher than 5 km/h
	While GPS fix is unavailable, Object Motion Detection Settings are working like in Msensor mode	
CAN speed	If speed from BT OBDII dongle is equal 0 km/h	If speed from BT OBDII dongle is higher that 0 km/h

Static Navigation Mode is a filter, which filters out track jumps when the object is stationary. If Static navigation filter is disabled, it will apply no changes on GPS data. If Static navigation filter is enabled, it will filter changes in GPS position if no movement (configured movement source) or ignition (configured ignition source) is detected (depends on what static navigation settings is selected: movement, ignition or both sources). It allows filtering GPS jumps when object is parked (is not moving) and GPS position is still traced.

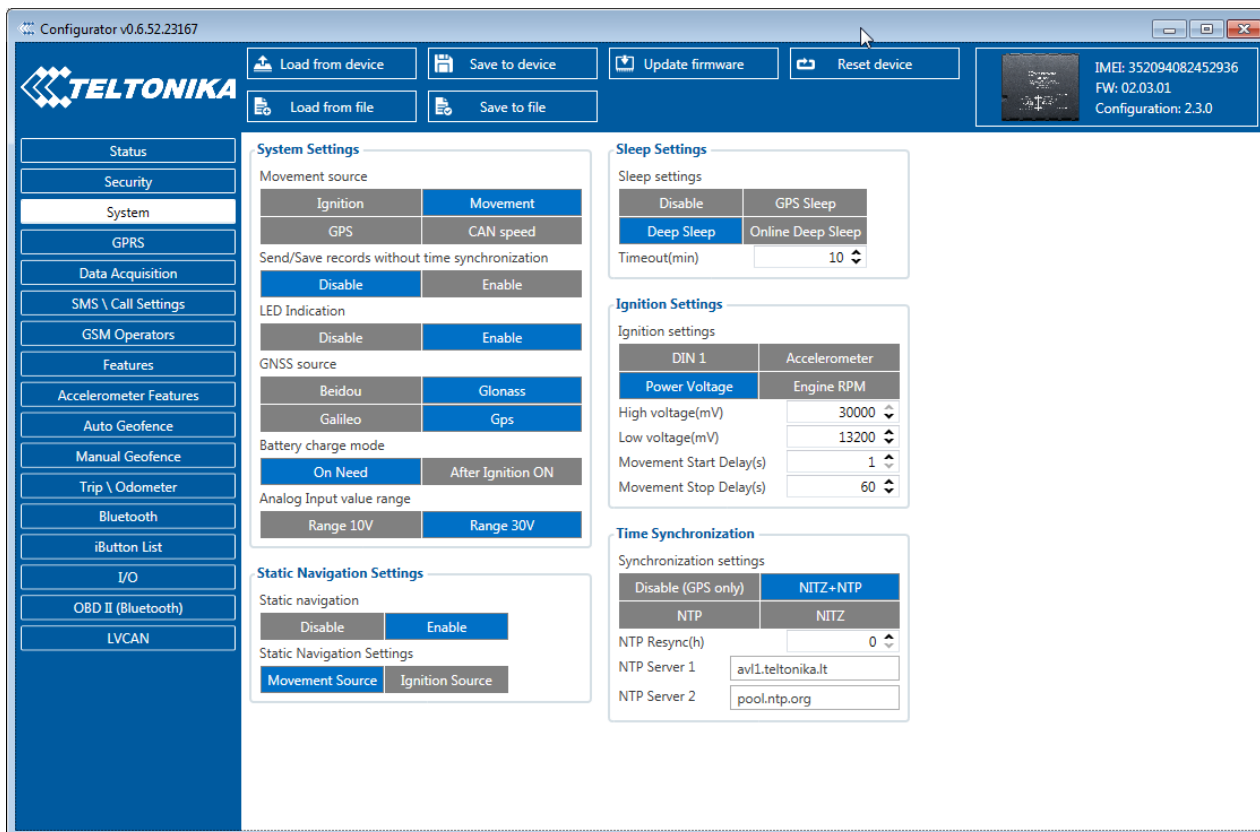

Figure 12 System settings configuration

In GNSS source Settings user can configure which GNSS system or systems to use.

User has choice to use only one system of GPS, Glonass, Galileo or Beidou. Also it is able to choose two or three systems together. One exception is that you can not combine Beidou and Glonass systems together.

List of configurable GNSS sources:

Beidou only	ID:01
Glonass only	ID:02
Galileo only	ID:04
Galileo+Beidou	ID:05
Galileo+Glonass	ID:06
GPS only	ID:08
GPS+Beidou	ID:09
GPS+Glonass	ID:10
GPS+Galileo	ID:12
GPS+Galileo+Beidou	ID:13
GPS+Galileo+Glonass	ID:14

List of **NON**-configurable GNSS sources:

- Glonass+Beidou
- Galileo+Glonass+Beidou
- GPS+Glonass+Beidou
- GPS+Galileo+Glonass+Beidou

GNSS source

Beidou	Glonass
Galileo	Gps

Example of good configuration

GNSS source

Beidou	Glonass
Galileo	Gps

Example of bad configuration

5.5 GPRS

'GPRS' defines main parameters for FMB1YX: GSM operator APN and GPRS username and password (optional – depending on operator), destination server IP and port, and allows to set protocol used for data transfers – TCP or UDP. SIM1 and SIM2 GPRS settings can be configured separate. Also all server setting and backup server mode can be selected for backup server configuration.

Backup server has 3 different modes:

- Disable: backup server is not used.
- Backup: send to backup server if main server not available (Failed to open Link) or, main server response timeout is detected 5 times in row.
- Duplicate: send records to both servers (main and backup), delete record from sd card (or RAMS) only if both servers accepted records.

Some operators use specific authentication for GPRS session – CHAP or PAP. If any of these is used, APN should be entered as 'chap:<APN>' or 'pap:<APN>'. I.e. if operator is using APN 'internet' with CHAP authentication, it should be entered as 'chap:internet'. Information about APN and authentication type should be provided by your GSM operator.

Records settings. Here user can modify if FMB1YX device will send newest records first, meaning, that the most important thing is to know recent position of car, older records are being sent right after newest records arrive to AVL application.

Activate Data Link Timeout is used to set timeout of link between FMB1YX and AVL application termination. If FMB1YX has already sent all records it waits for new records before closing link (except Deep Sleep mode, more indoemation in Deep Sleep mode chapter). If new records are generated in the period of this timeout, and minimum count to send is reached, they are sent to AVL application. This option is useful when GSM operator charge for link activation.

Server Response Timeout is used to set time period waiting for response from server side.

FOTA WEB settings are used for FOTA WEB server connection parameters configuration. Status enables or disables FOTA WEB funkcionality. In domain and port user can enter address and port number of FOTA website. Period is used fot timeout of repeating connection to FOTA WEB server.

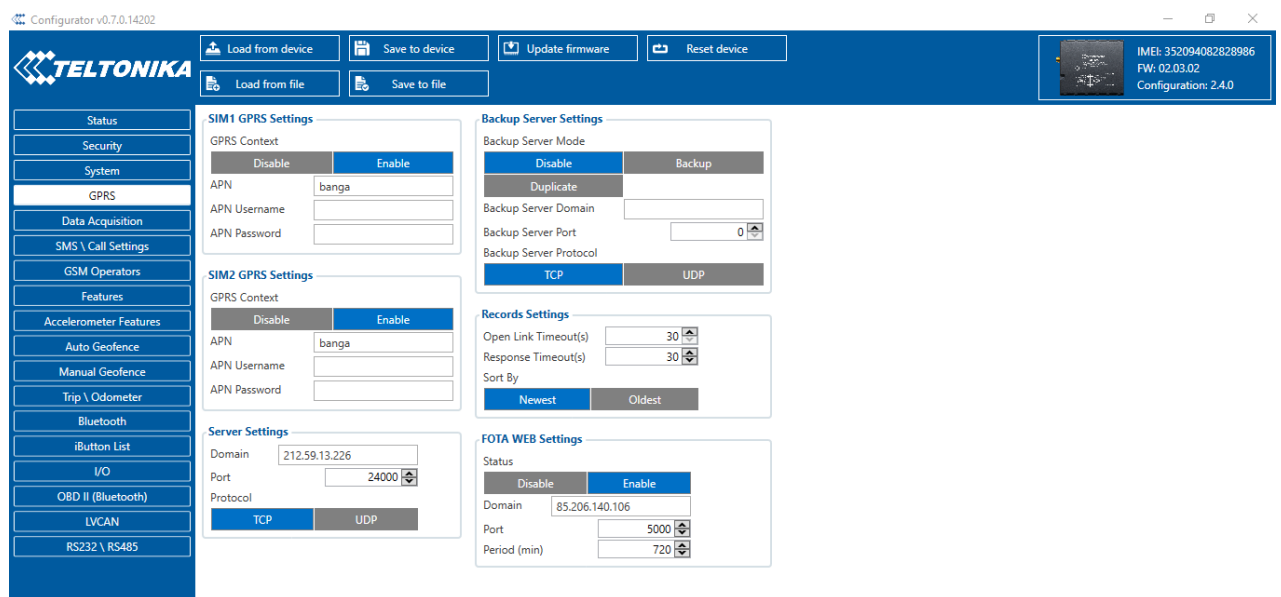

Figure 13 GPRS configuration

5.6 SMS/Call Settings

Essential fields in 'SMS' part is 'Login' and 'Password'. The login and password are used with every SMS sent to FMB1YX. If login and password are not set, in every SMS sent to FMB1YX device two spaces before command have to be used (<space><space><command>).

Command structure with set login and password:

<login><space><password><space><command>, example: "asd 123 getgps"

Phone numbers have to be written in international standard, with using "+" or without using it (in both cases number will be recognized, but when number is without "+" symbol, it will not generate IDD Prefix, which depends on location of phone). If no numbers are entered, configuration and sending commands over SMS are allowed from all GSM numbers.

SMS data sending settings allows or does not allow sending AVL data using binary SMS. AVL data will be send by SMS only when there are no GPRS connection. This setting does not affect replies to SMS request messages – answers are always sent back to sender telephone number.

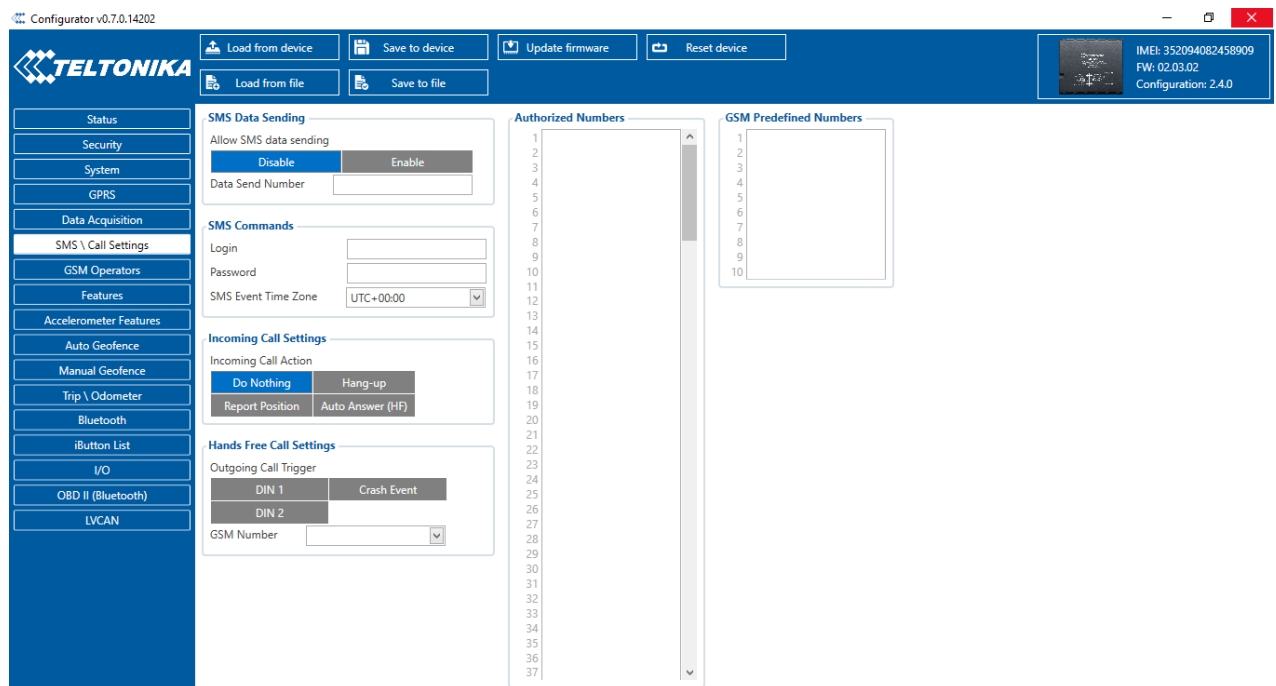

Figure 14 SMS \ call Settings configuration

Incoming Call Settings

This parameter defines device action during incoming call:

- Do Nothing
- Hang up – automatically hang up incoming call
- Report Position – Report position to calling number via SMS
- Auto Answer (HF) – Auto answer incoming call if hands free device is connected. If hands free device is not connected, then incoming call will be hanged up.

Hands free call functionality

When FMB1YX is connected to hands free headset it can call to user defined GSM numbers.

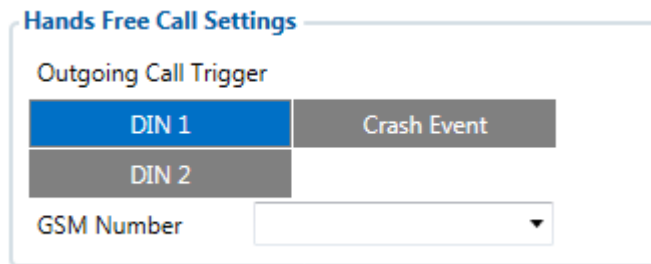

Figure 15 Hands Free Call Settings configuration for FMB120 and FMB122¹

Outgoing Call Trigger parameter determines which event will triggers call. FMB125 supports first for different call triggers and FMB120/FMB122 supports all eight call triggers:

- None selected – disables call trigger functionality.
- DIN1 – first digital input event triggers call to user selected GSM number.
- Crash Event – crash event triggers call to user selected GSM number.
- DIN1 and Crash Event – both events triggers call to user selected GSM number.
- DIN2 – seconf digital input event triggers call to user selected GSM number.
- DIN1 and DIN2 Event – both events triggers call to user selected GSM number.
- DIN2 and Crash Event – both events triggers call to user selected GSM number.
- DIN1, DIN2 and Crash Event – all events triggers call to user selected GSM number.

SMS Event Time Zones

FMB1XX works with synchronized GPS time which is UTC+0, with this option customer can configurate his time zone and get SMS with correct time.



Note: Please do not set Data Send Number to some cell phone number, because it will not understand binary SMS. When sending a binary SMS to a phone number, which is a server phone number, the server can interpret and understand binary code, so the data can be read and you can view it on the server.



SMS login and password and authorized number list are used to protect FMB1YX module from unauthorized access. Module accepts messages only from a list of authorized numbers and with proper module login and password. Phone numbers have to be written in international standard, with using “+” or without using it (in both cases number will be recognized). If no authorized numbers are entered, module accepts messages from all numbers.

¹ FMB125 don't have DIN2 selection

5.7 GSM Operators, SIM1 Roaming and SIM2 Roaming/ Home Operator list, Blacklist Operator list

Operators list – FMB1YX can work in different modes (use different settings) according to the operator list defined. Operator list is used for Data Acquisition Mode switching (see [Data Acquisition Mode settings](#) chapter for more details). Modes are changed based on GSM operator FMB1YX is connected to.

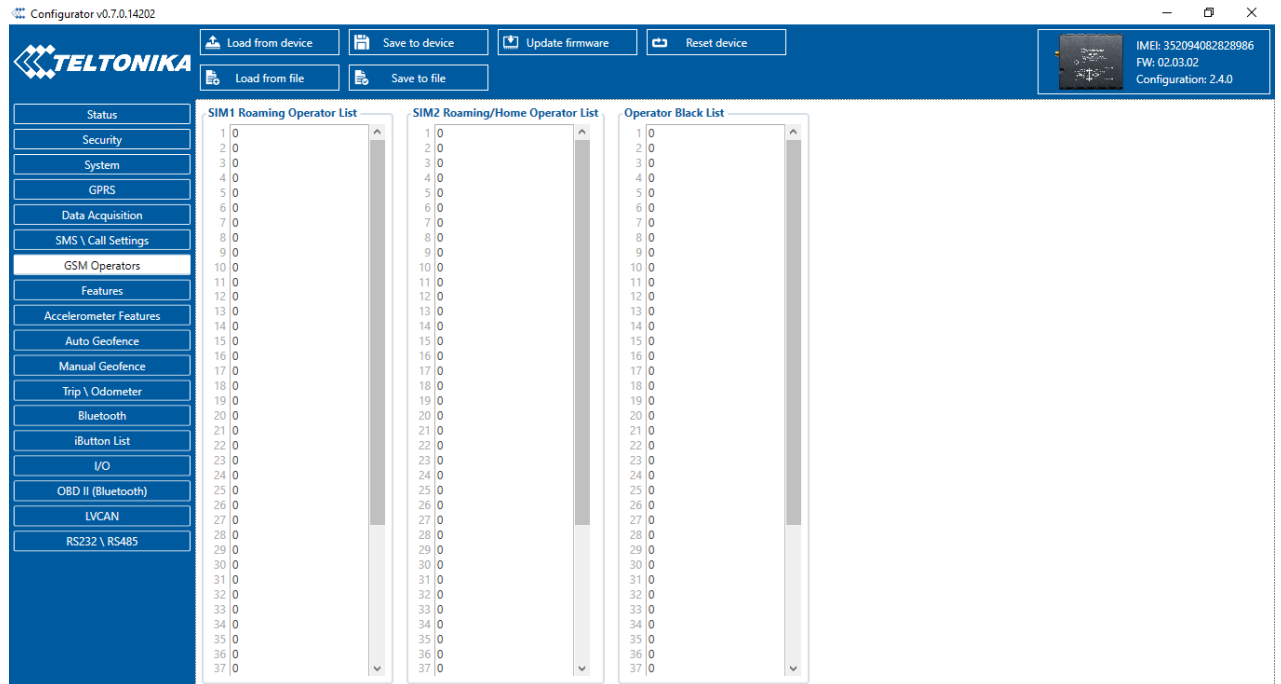

Figure 16 SIM1 Roaming, SIM2 Roaming/ home Operators and Operator BlackList configuration

If roaming operator list is left empty, FMB1YX will automatically detect home operator. If home operator will be written to roaming operator list any part, it will be detected as home operator, not roaming. Any not written operator in roaming operator list (not home operator) will be recognized as unknown operator and FMB1YX will work in **Unknown mode** (make sure it is configured to allow data sending – GPRS context is enabled).

Operator Blacklist - if user wants that FMB1YX do not connect and work with a particular operator it must be written to Operator BlackList. Total 50 operators can be written to this list.

Operator Blacklist working: operator search procedure is initiated as normal every 15 minutes and tries to connect to an operator with the strongest signal. It will prioritize operators which are specified in the operator list. If no operators from the operator list are available, the device will try to connect to an operator from the blacklist. If device connects to operator from black list – best operator search procedure is initiated instantly. During the time when device is connected to Black list operator - no GPRS connection would be initiated and no data would be send via GPRS. The ability to send SMS commands to the device remains. If no suitable operator is found on both lists, the device will try to connect to a remaining available operator with the strongest signal.



In SIM2 Roaming/ Home Operator list home operator must be added to the any part of the list that functionality works correctly.

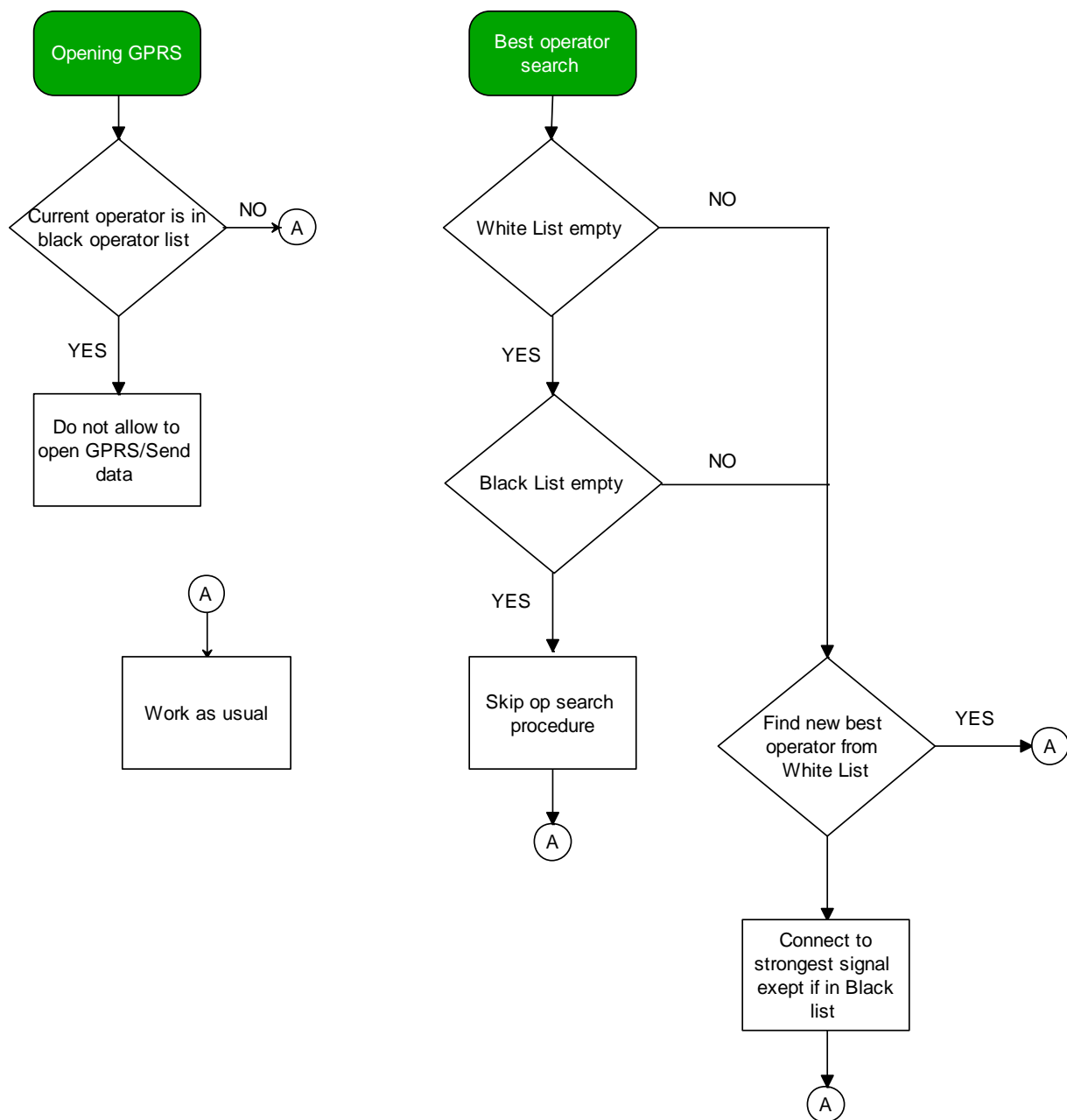

Figure 17 Operator search functionality diagram. White list is SIM1 Roaming and SIM2 Roaming/ Home Operator lists.

5.7.1 Dual SIM

FMB1YX have possibility to have inserted in them two SIM cards. GPRS settings and Roaming Operators can be configurd separate for SIM1 and SIM2. In SIM2 Roaming/ Home operator list home operator must be added to the any part of the list that functionality works correctly. Dual SIM operator search functionality works like that: SIM1 and SIM2 home operators have highest priority: When device is connected to home operator - manual roaming operator search is disabled. When device is disconnected from home operator - operator search procedure is initiated as normal every 15 minutes. SIM1 Roaming operators list has higher priority then SIM2 Roaming Operator list. When device finds new operator from SIM1/SIM2 lists – it switches to new SIM according to list and connects to new operator.

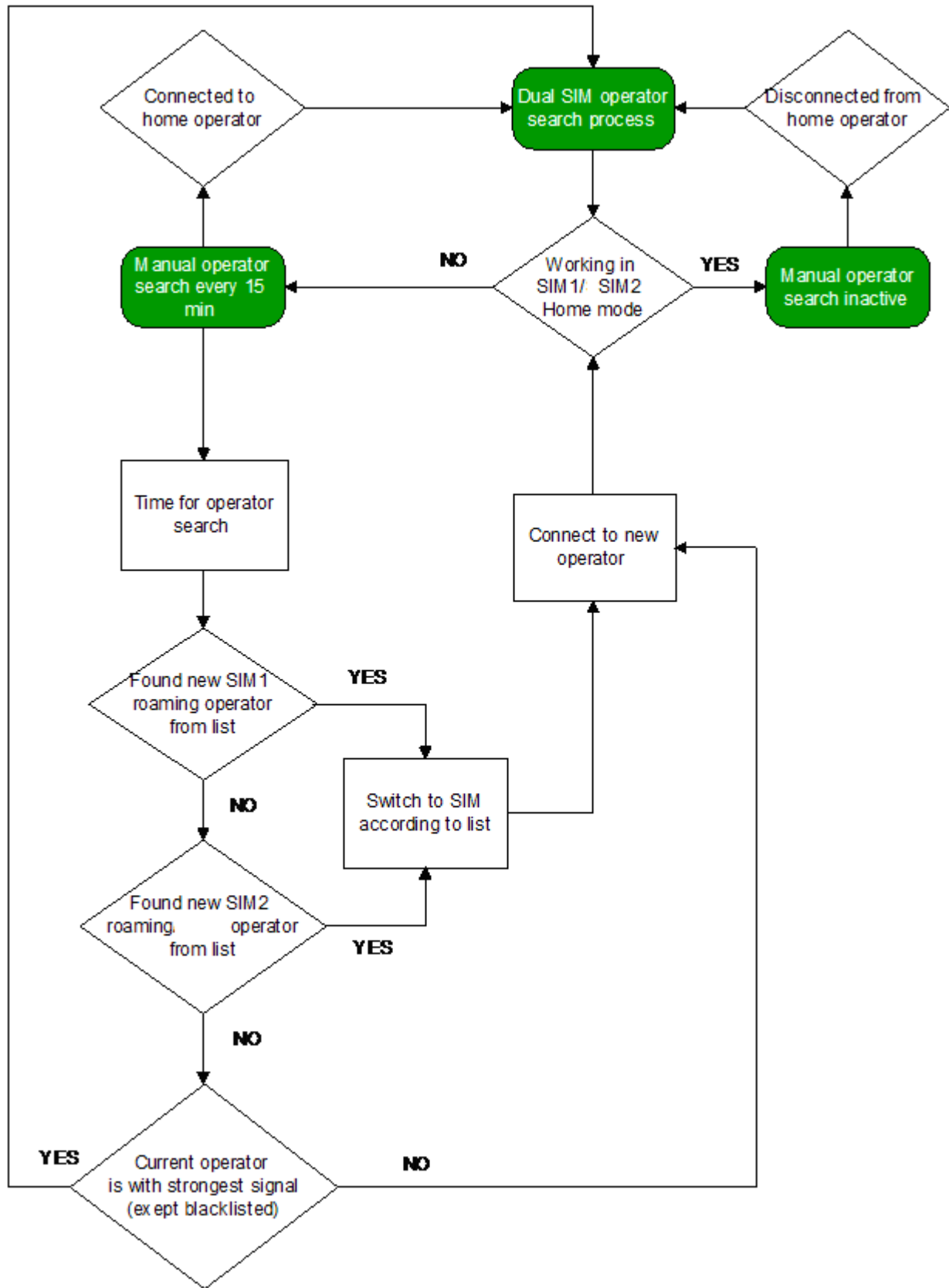

Figure 18 Dual SIM functionality diagram.

5.8 Data Acquisition Mode settings

Data Acquisition Modes are an essential part of FMB1YX device, it is also highly configurable.

By configuration user defines how records will be saved and sent. There are three different modes: Home, Roaming and Unknown. All these modes with configured data acquisition and send frequencies depend on current GSM Operator defined in Operator list (see chapter GSM Operators, Roaming and Blacklist Operator list) and are switched when GSM operator changes (e.g. vehicle passes through country boarder).

If current GSM operator is defined as Home Operator, device will work in Home Data Acquisition mode, if current operator is defined as Roaming Operator, device will work in Roaming Data Acquisition mode, and if current operator code is not written in Roaming Operator list, device will work in Unknown Acquisition mode.

This functionality allows having different AVL records acquire and send parameters values when object is moving or stands still. Vehicle moving or stop state is defined by Stop Detection Source parameter. There are 4 ways for FMB1YX to switch between Vehicle on Stop and Vehicle Moving modes, see section 5.4 , Table 12. Object Motion Detection Settings.

FMB1YX has 6 different modes. Operational logic is shown in Figure 19.



If home operator will be written to roaming operator list any part, it will be detected as home operator, not roaming.

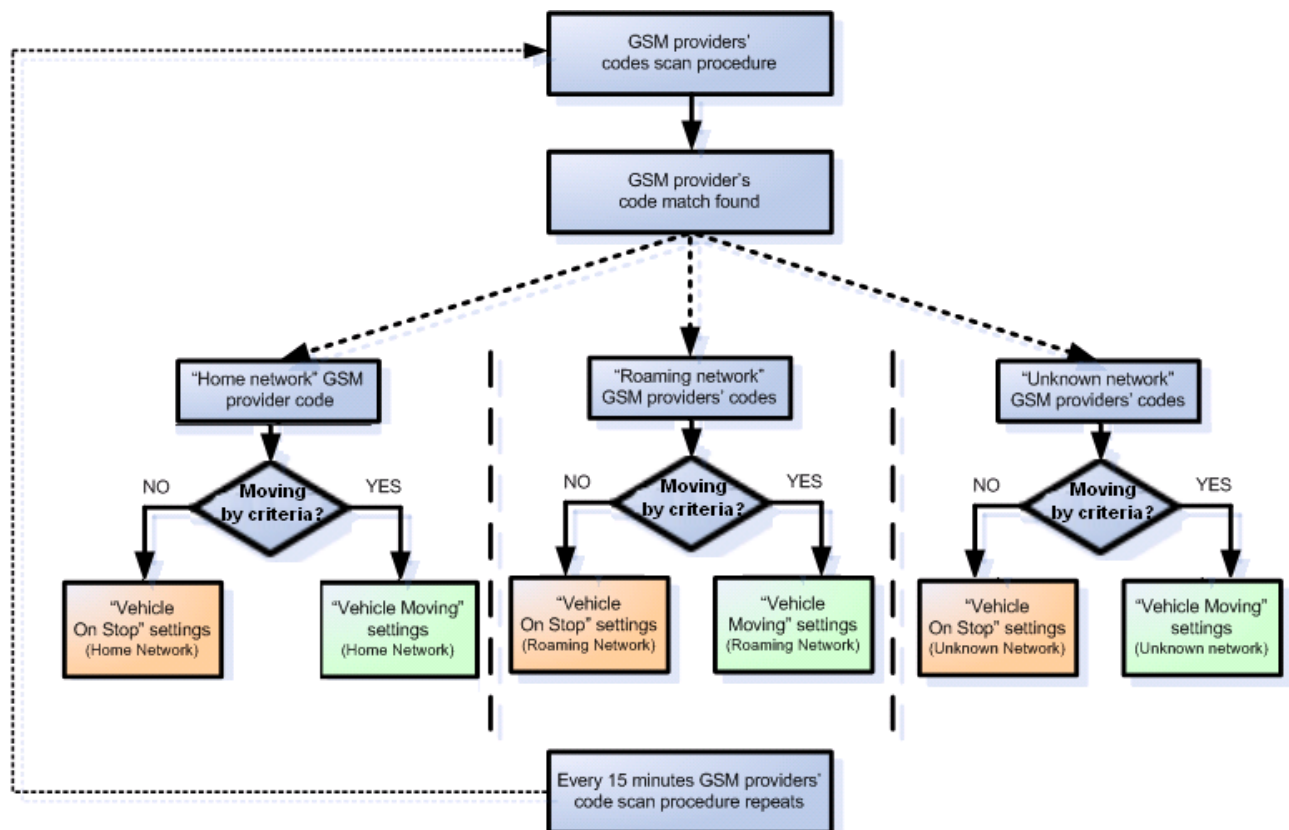

Figure 19 Data Acquisition Mode operational logic

Operator search is performed every 15 minutes. Depending on current GSM operator, Home, Roaming or Unknown mode can be changed faster than every 15 minutes. This process is separate from operator search. Movement criteria are checked every second.

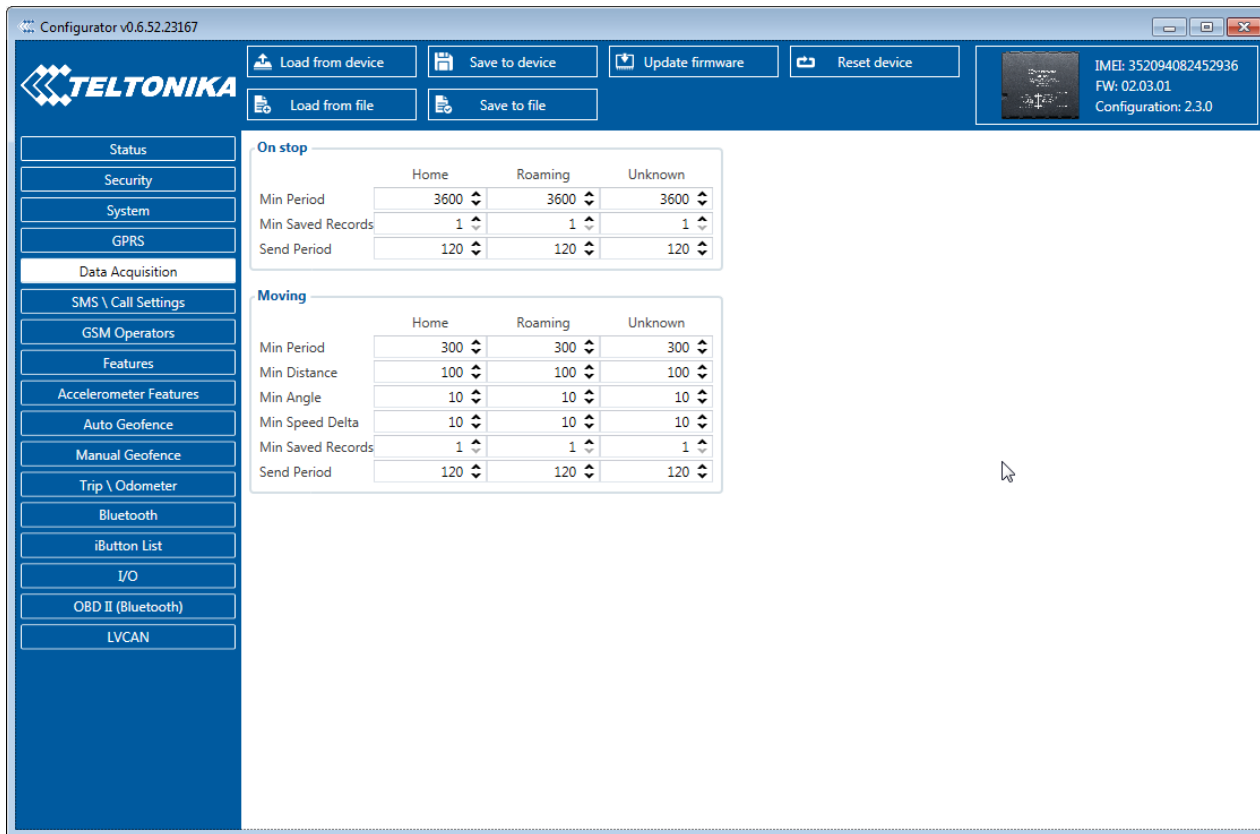

Figure 20 Data Acquisition Mode configuration

‘Min Saved Records’ defines minimum number of coordinates and I/O data that should be transferred with one connection to server. If FMB1YX does not have enough coordinates to send to server, it will check again after time interval defined in ‘Sending Period’.

Send period – GPRS data sending to server period. Module makes attempts to send collected data to server every defined period. If it does not have enough records (depends on parameter Min. Saved Records described above), it tries again after defined time interval.



Note: Keep in mind that FMB1YX operates in **GMT:0** time zone, without daylight saving.

FMB1YX is able to collect records using four methods at the same time: time, distance, angle and speed based data acquisition:
 Time based data acquiring (Min. period) – records are being acquired every time when defined interval of time passes. Entering zero disables data acquisition depending on time.

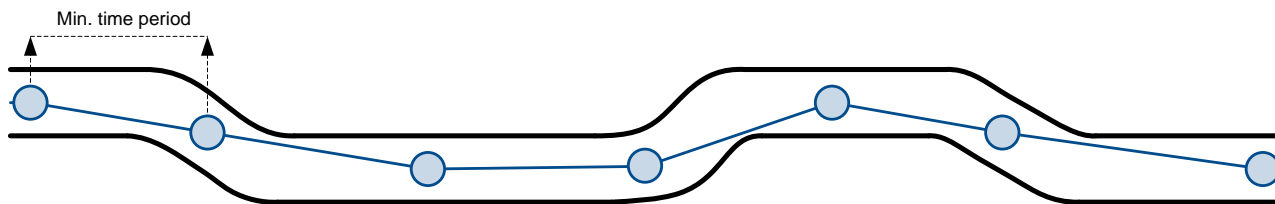

Distance based data acquiring (Min. distance) – records are being acquired when the distance between previous coordinate and current position is greater than defined parameter value. Entering zero disables data acquisition depending on distance.

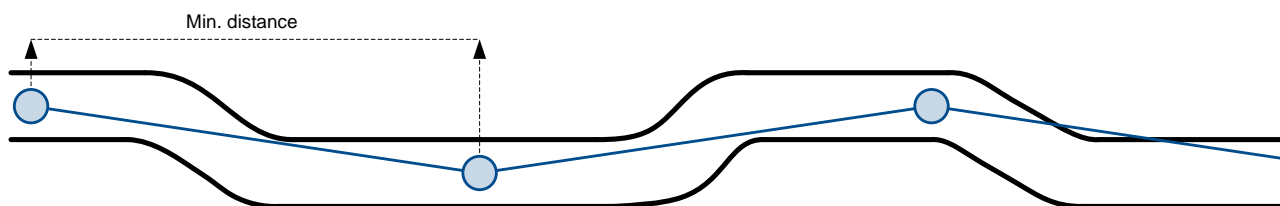

Angle based data acquiring (Min. angle) – records are being acquired when angle difference between last recorded coordinate and current position is greater than defined value. Entering zero disables data acquisition depending on angle.

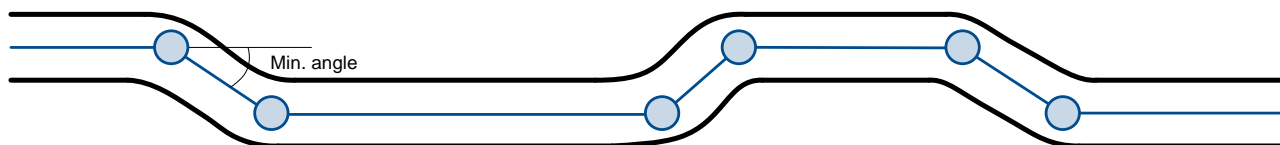

Speed based data acquiring (Min. Speed Delta) – records are being acquired when speed difference between last recorded coordinate and current position is greater than defined value. Entering zero disables data acquisition depending on speed.



5.9 Features settings

In Features window five different scenarios and GPS fuel counter are available.

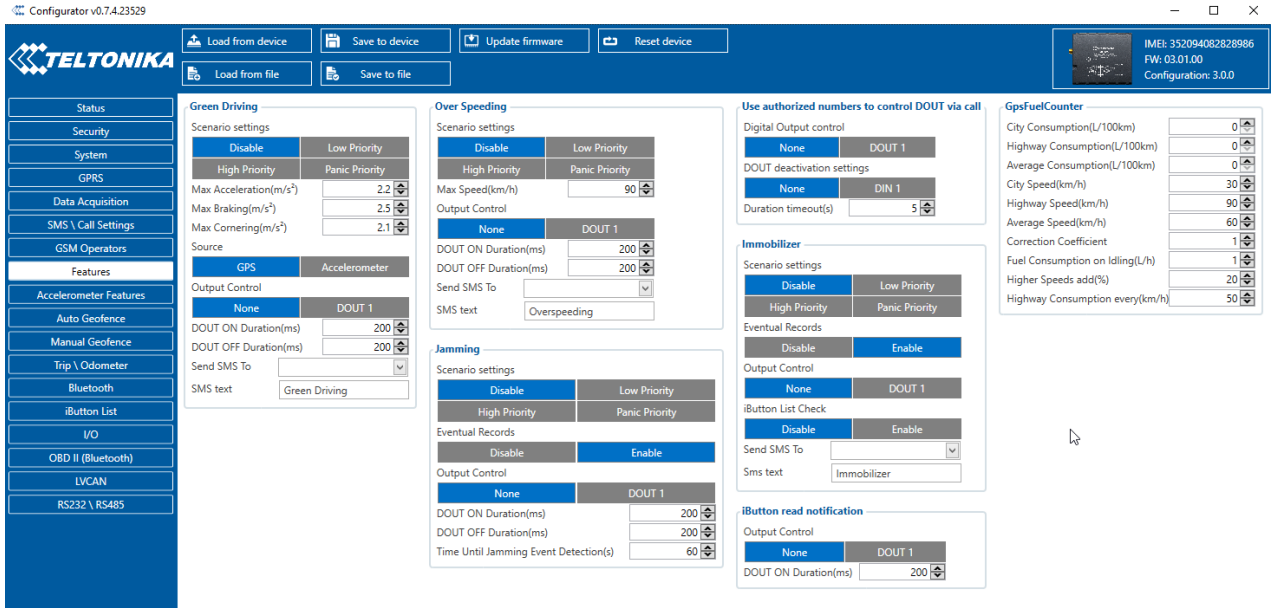

Figure 21 Scenarios configuration

5.9.1 Green Driving

When vehicle exceeds on of Max Acceleration, Max Braking or Max Cornering parameters value, scenario is activated, record will be generated and digital output status will be changed to 1 (if configured). You can configure all three parameters in m/s^2 (meter per second squered) units. Scenario is activated until current Acceleration, Braking or Cornering value decreases below parameter value.

Parameters used with Green Driving functionality.

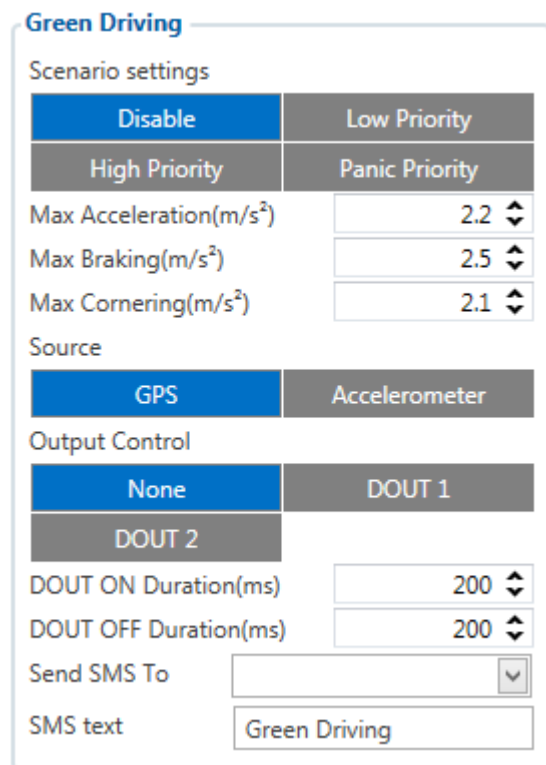

Figure 22 Green Driving configuration parameters for FMB120 and FMB122¹

¹ FMB125 don't have DOUT 2 selection

Table 13. Green driving parameters description

Green driving configuration parameter name	Description
Scenario settings	Enable/Disable Green driving functionality.
Max Acceleration Force	Value which can be reached while accelerating without triggering harsh acceleration event.
Max Braking Force	Value which can be reached while braking without triggering harsh braking event.
Max Cornering Force	Value which can be reached while cornering without triggering harsh cornering event.
Source	From what source (GPS or accelerometer) data will be collected.

5.9.1.1 Data output

Green driving functionality generates events on three cases. If vehicles:

- Acceleration exceeds defined parameter value
- Deceleration (braking) exceeds defined value
- Cornering force exceeds defined value

Program continuously monitors and process data from accelerometer/GPS than decides whether harsh event is detected or not. If any of three cases are satisfied event is generated. Record is saved and sent to server (FMB1YX must be configured properly). Event value is multiplied by 10 before sending/saving record to get more precision when displaying **data***.

Digital output 1 or digital output 2 can be activated for a period of time to warn driver. Output on-time should/can be configured separately for each feature case.

***Example.** If acceleration harsh event of 3.55 m/s² detected. Record with value $3.55 \times 10 = 35.5 \approx 36$ will be saved and sent to server.

5.9.1.2 Auto Calibration

1. Vehicle stopped
2. Road is straight
3. Send SMS "auto_calibrate"
4. Accelerate to > 30 km/h for 5 sec.
5. FMB will send response when calibration is success.

Calibration is saved to Internal Flash, after restart should be the same

To check autocalibration status send: position_info

To zero out accelerometer axis SMS: "calibrate", can be used, vehicle speed must be 0 km/h.

5.9.2 Over Speeding

When vehicle speed exceeds configured max speed value scenario is activated, record will be generated and digital output status will be changed to 1 (if configured).

Scenario is activated until current speed decreases below parameter value.

Over Speeding

Scenario settings

Disable	Low Priority
High Priority	Panic Priority

Max Speed(km/h)

Output Control

None	DOUT 1
DOUT 2	

DOUT ON Duration(ms)

DOUT OFF Duration(ms)

Send SMS To

SMS text

Figure 23 Over Speeding configuration parameters for FMB120 and FMB122¹

5.9.3 Jamming

When jamming is detected scenario is activated, record will be generated and digital output status will be changed to 1 (if configured).

Jamming timeout time can be configured. After jamming trigger count configured timeout (in seconds), digital output control and jamming event will be generated after this timeout. If jamming ends during timeout counting no event will be generated and output will not be controlled.

You can configure eventual records parameter: when he is disabled scenario status value will be appeared in each AVL record, and when he is enabled scenario status value will be appended only to eventual records.

Jamming

Scenario settings

Disable	Low Priority
High Priority	Panic Priority

Eventual Records

Disable	Enable
---------	--------

Output Control

None	DOUT 1
DOUT 2	

DOUT ON Duration(ms)

DOUT OFF Duration(ms)

Time Until Jamming Event Detection(s)

Figure 24 Jamming configuration parameters for FMB120 and FMB122²

¹ FMB125 don't have DOUT 2 selection

² FMB125 don't have DOUT 2 selection

5.9.4 Use authorized numbers to control DOUT via call

Scenario is activated and digital output is ON, when call is received from number which is in authorized numbers list.

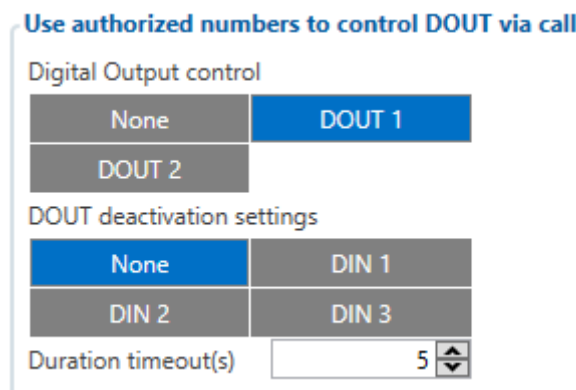

Figure 25 DOUT control via call configuration parameters for FMB120 and FMB122¹

Call control functionality²:

- When FMB1YX is configured to control *DOUT1/DOUT2* device waits incoming call from configured secure number. If call is received FMB1YX turns on *DOUT1/DOUT2* for user defined *Duration timeout (s)*. If *Duration timeout* set to „0“(s), *DOUT1/DOUT2* will be OFF.
- *DOUT1/ DOUT2* can be turned off by *Duration timeout (s)* or by *digital input 1, digital input 2 or digital input 3 (DOUT deactivation settings)*.
- *DOUT1/DOUT2* can be turned off before *Duration timeout (s)* by selected *DIN (DOUT deactivation settings)*.
- *DOUT1/DOUT2* always will be ON, if *DOUT deactivation* set to *DIN1* for example, but *DIN1* will be never turned ON or set *Duration timeout* to *Max* value (2147483647) it is about 68 years.

5.9.5 Immobilizer

If *Dout Control* is disabled, scenario will only generate events without digital output activation. If *Dout Control* is enabled *DOUT1/DOUT2* (optional) turns ON if Ignition turns ON (configured Ignition Source =1). After iButton ID is read (any iButton is attached), *DOUT1/DOUT2* turns OFF. After iButton identification, Ignition (configured Ignition Source) can be turned OFF (configured Ignition Source =0) for no longer than 30 seconds³, otherwise immobilizer must be

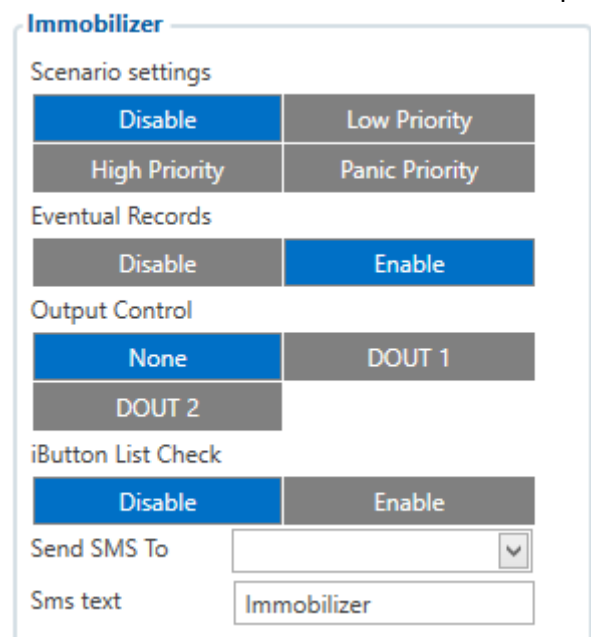

Figure 26 Immobilizer configuration parameters for FMB120 and FMB122³

¹ FMB125 don't have DOUT 2, DIN 2 and DIN 3 selection

² FMB125 don't have DOUT 2, DIN 2 and DIN 3 selection

³ FMB125 don't have DOUT 2 selection

repeated. If iButton list checking parameter is enabled, authorization will be successful only if attached iButton is specified in the iButton list.

5.9.6 iButton read notification

This functionality allows user to see when iButton is being read. Selected DOUT¹ turns on for configured duration, after DOUT ON duration ends configured DOUT don't turns on, even if iButton is left attached.

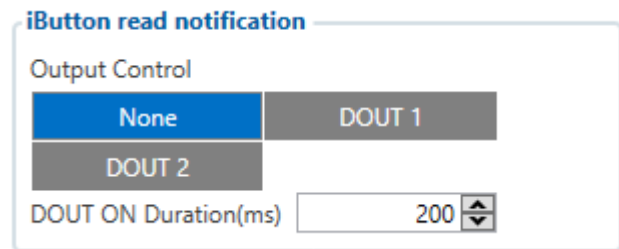

Figure 27 iButton read notification configuration parameters for FMB120 and FMB122¹

5.9.7 GPS Fuel Counter

Configuration of Fuel Consumption

1. To configure this parameters use fuel consumption norm which are presented in your car technical documentation. By default speeds for this fuel consumption norms are: City – 30 km/h, Average - 60km/h, Highway - 90 km/h. If you want, you can change it.
2. When speed are higher than highway fuel consumption speed, we add for highway fuel consumption x % of highway fuel consumption every y km/h, by default FMB1YX add 20% every 50 km/h. It means that fuel consumption is (1.2 * Highway Fuel Consumption) on 140 km/h speed, (1.4 * Highway Fuel Consumption) on 190 km/h speed.
3. Correction coefficient is use for correction every value of fuel consumption which is send to server (Used Fuel * Correction coefficient). By default it is 1, min 0.01 and max 2. For example when correction coefficient is 1 and FMB1YX calculate that used fuel of 35 m distance is 20 ml, to server will be sent value: 20 ml, if correction coefficient is 1.2 to server will be sent value: 20 * 1.2 = 24 ml.
4. Fuel consumption on idling used to calculate fuel consumption when ignition is on, but vehicle speed is 0 km/h. By default it is 1 l/h, min 0 and max 5 l/h. Almost in all diesel cars this parameter is less than 1.0 l/h. In gasoline cars this parameter is about 1.5 – 2.0 l/h.

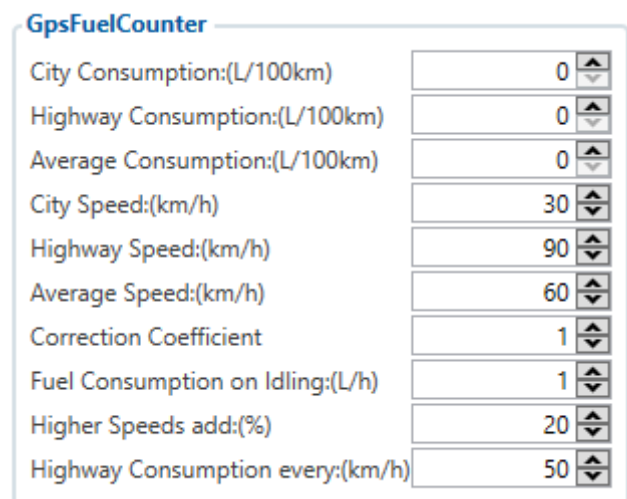

Figure 28 GPS Fuel Counter configuration

5.10 Accelerometer Features

¹ FMB125 don't have DOUT 2 selection

5.10.1 Excessive Idling

When vehicle stops for specific amount of time scenario is activated, record will be generated and digital output status will be changed to 1 (if configured). You can configure time it takes to turn on this scenario (Time to Stopped). Scenario is activated until vehicle starts moving and keeps moving (moving is detected only from accelerometer) for amount of time that is configured. You can configure time it takes to turn OFF this scenario (Time to Moving).

The screenshot shows the 'Excessive Idling' configuration window. It includes a 'Scenario settings' section with buttons for 'Disable', 'Low Priority', 'High Priority', and 'Panics Priority'. Below that is the 'Eventual Records' section with 'Disable' and 'Enable' buttons. The 'Time To Stopped(s)' is set to 300 and 'Time To Moving(s)' is set to 5. The 'Output Control' section has buttons for 'None', 'DOUT 1', and 'DOUT 2'. 'DOUT ON Duration(ms)' and 'DOUT OFF Duration(ms)' are both set to 200. There is a 'Send SMS To' dropdown menu and an 'SMS text' field containing 'Idling Event'.

Figure 29 Excessive Idling configuration parameters for FMB120 and FMB122¹

5.10.2 Unplug Detection

Unplug Detection. Eventual event will be generated when FMB1YX is unplugged from external power or plugged back again. User can select detection type: simple – used in cars, where power voltage is not dependant on ignition (recommended); advanced – used in cars, where power voltage is disconnected when ignition is switched off.

The screenshot shows the 'Unplug' configuration window. It includes a 'Scenario settings' section with buttons for 'Disable', 'Low Priority', 'High Priority', and 'Panics Priority'. Below that is the 'Eventual Records' section with 'Disable' and 'Enable' buttons. The 'Unplug Detection Mode:' section has buttons for 'Simple' and 'Advanced'. There is a 'Send SMS To' dropdown menu and an 'Sms text' field containing 'Unplug'.

Figure 30 Unplug detection configuration

5.10.3 Towing Detection

FMB1YX activates towing function when these conditions are met:

1. Ignition (configured Ignition Source) is OFF.
2. Activation Timeout (set in Towing detection features) is reached.

When Activation Timeout is reached and Ignition is still in OFF state, FMB1YX monitors accelerometer data. If Acceleration or Angle value reaches configured threshold for configured Duration (in ms), check Ignition state. If Ignition is still OFF during configured "Ignition check after

¹ FMB125 don't have DOUT 2 selection

Event Timeout" time, then event is generated. If configured - sends sms event or makes a call. Function will be reactivated after FMB1YX again detects change of Ignition state from ON to OFF.

Activation timeout – Activation timeout is time after which FMB1YX turns ON Towing detection function if other requirement is met (Ignition OFF state detected). It is measured in minutes.

Event timeout – defines time period (in seconds) to check ignition state when Acceleration or Angle value reach. If towing event is generated during this time period, it is skipped. It allows filtering out redundant towing events while entering the car.

Make Call to – if function enabled makes call to specified phone number (configured in predefined numbers).

Threshold and Angle – values used to detect towing when ignition is OFF.

Duration – defines time period to check Acceleration and Angle values.

Figure 31 Towing detection configuration

5.10.4 Crash Detection

Crash Detection functionality can be set according to these settings:

1. Threshold (mg)
2. Duration (ms)

If accident happens and FMB1YX detects acceleration value higher than set threshold value during set time period, then device will generate an event. Threshold and duration values are set depending of accident power which you want to detect. FMB1YX can detect a slight tapping on the device (Threshold=100mg, Duration=1ms) or can detect severe accident (Threshold=4000mg, Duration=5ms).

Crash Trace operation:

If trace is enabled FMB will collect acceleration data every 40 msec., and in the deep-sleep mode too. Buffer is big enough to hold data for 5 seconds and on Crash Event detection, records will be generated from this buffer, following these conditions:

1. Every second Acceleration changed more then > 50mG.
2. Data will be collected and records generated 5 seconds after the event using the same conditions.
3. Every generated record will have accelerometer x y z values included.
4. Each record will have accurate timestamps in milliseconds.

Usually between 20 to 30 records is generated on crash event detection.

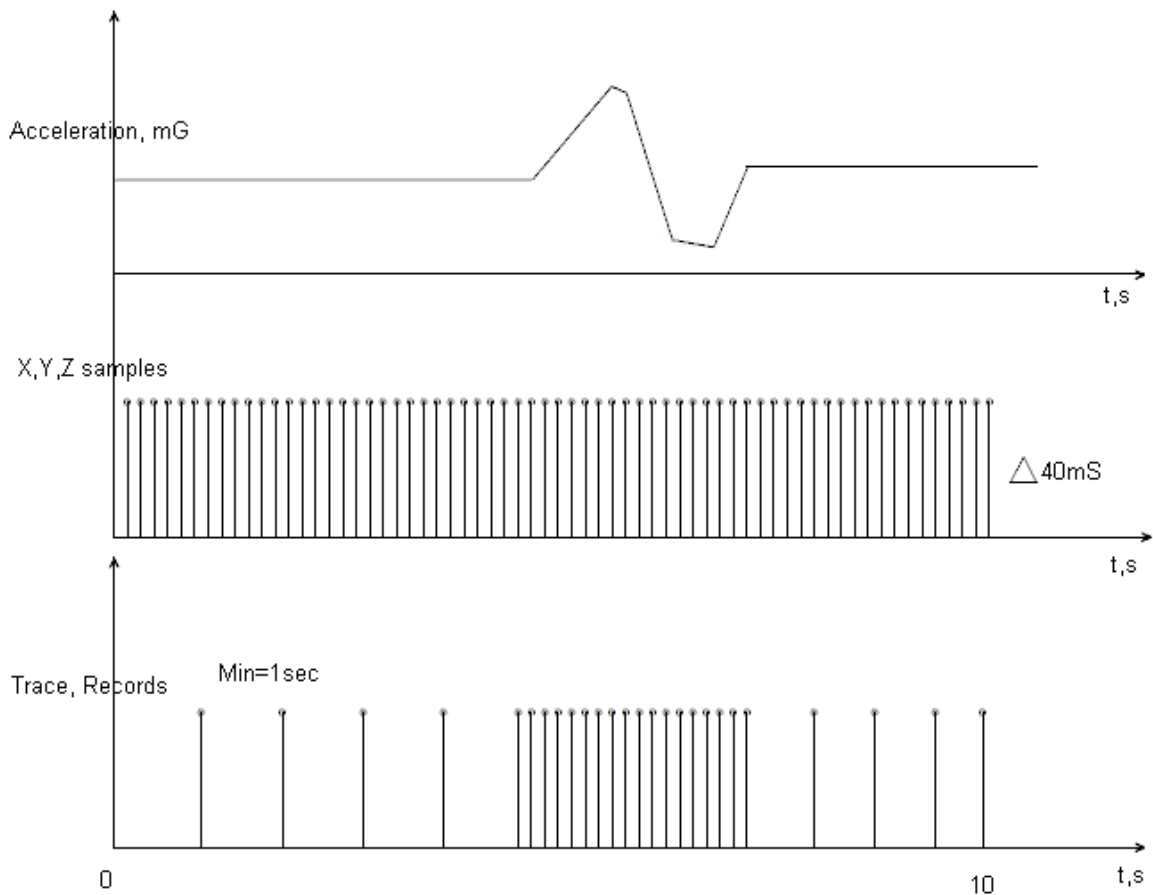

Figure 32 example of Crash Trace logic

Crash

Scenario settings

Disable	Low Priority
High Priority	Panic Priority

Duration(ms)

Threshold(mg)

Send SMS To

SMS text

Crash Trace

Disable	Enable
---------	--------

Figure 33 Crash detection configuration

5.11 DOUT ON/OFF Duration

In all scenarios that control Digital Output, Digital Output can be controlled independent from scenario.

DOUT ON Duration parameter shows for how long DOUT is set on after scenario is activated and DOUT OFF Duration parameter shows how long DOUT is set off after DOUT ON duration ends. After DOUT OFF duration ends, DOUT ON duration will be counted again. This

period continues until scenario turns off. DOUT ON and DOUT OFF duration parameters must be configured in ms.

5.12 DOUT control depending on functionality priority

All DOUT control functionalities now have their own priority (non-configurable). Depending on priority DOUT control may be overtaken by higher priority functionality without finishing previous scenario.

DOUT control scenarios and functionalities by priority:

- Immobilizer (highest priority)
- DOUT control via call
- iButton Notification
- Green Driving
- Jamming
- Overspeeding
- Idling
- DOUT control via SMS (lowest priority)

For example, if jamming will be detected during Overspeeding, then Jamming functionality will control DOUT.

5.13 AutoGeofencing settings

AutoGeofence – the last known position after movement = off. If your car's being taken away – you can be notified. The shape and size of the geofence zones are parameters. It is possibility to state whether entering in or out of the geofence triggers an asynchronous message.

AutoGeofencing option can be configured by following parameters visible in figure 34 below.

Activation Timeout (s) – when ignition is turned off and activation timeout passes, as AutoGeofence will be created around vehicle last position with set radius value.

Radius (m) – radius of circle with center device coordinates after activating AutoGeofence feature.

Deactivate By:

Digital Input 1 – If DIN1 voltage becomes equal or higher than 6,9 V it will disable AutoGeofence Zone.

Digital Input 2¹ – If DIN2 voltage becomes equal or higher than 2,1 V it will disable AutoGeofence Zone.

Digital Input 3² – If DIN3 voltage becomes equal or higher than 3,5 V it will disable AutoGeofence Zone.

iButton – if authorized iButton is attached.

Power Voltage – if power voltage become higher that low voltage level (Ignition settings) it will disable AutoGeofence Zone.

Engine RPM – If engine RPM became higher that 0 it will disable AutoGeofence Zone.

Feature – Priority of generated event, which will be applied to saved record.

¹ FMB125 don't have Digital Input 2 selection

² FMB125 don't have Digital Input 3 selection

Enter Event – Event generation on Geofence entrance.

Exit Event – Event generation on Geofence exit.

On Both - Event generation on Geofence entrance Or exit

Eventual Records – Enable or Disable Eventual Records functionality.

Note that AutoGeofencing does not require entering coordinates, instead it requires GPS visibility. If vehicle stopped and activation timeout has passed, an AutoGeofence will be created around vehicle's last position with set Radius value.

Geofence

Scenario settings

Disable	Low Priority
High Priority	Panic Priority

Eventual Records

Disable	Enable
---------	--------

Generate Event

On Exit	On Entrance
On Both	

Activation Timeout(s)

Radius(m)

Deactivate By

Power Voltage	Digital Input 1
Digital Input 2	Digital Input 3
Engine RPM	iButton

Send SMS To

SMS text

Figure 34 Auto Geofence configuration parameters for FMB120 and FMB122¹

5.14 Manual Geofence

FMB1YX has 50 configurable Geofence zones and it can generate an event when defined Geofence zone border is crossed.

Frame border – frame border is an additional border around Geofence zone. It is additional area around defined zone used to prevent false event recording when object stops on the border of the area and because of GNSS errors some records are made inside area and some – outside. Event is generated only when both borders are crossed. See **figure 35** for details: blue track is considered to have entered the area while red track is not.

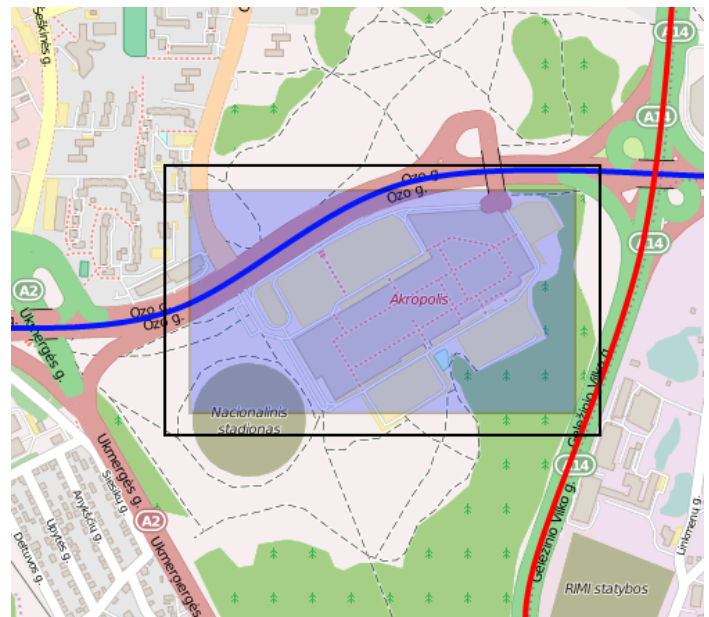

Figure 35 Geofence border

Shape – can be rectangle or circle. User can choose what geozone shape will be.

Priority – priority of Geofence event: low, high or panic. These levels define priority of event information sending to server. See I/O element description for more details about priorities in I/O settings chapter.

¹ FMB125 don't have Digital Input 2 and Didital Input 3 selection

Generate event (On entrance, On exit, On Both) – choose when record will be generated.

Eventual records – when disabled scenario status value will be appeared in each AVL record, and when enabled scenario status value will be appended only to eventual records.

OverSpeeding – in each geozone OverSpeeding scenario can be configured separately. Regular OverSpeeding functionality and geozones OverSpeeding functionality is working independently. If digital output control is enabled in regular OverSpeeding scenario, geozones OverSpeeding scenario controls it too. If device is in more that one geozone and OverSpeeding is detected in any zone then digital output turns on. Digital output turns off only when OverSpeeding is not detected anywhere (regular OverSpeeding and geozones OverSpeeding).

X1 – geofence zone left bottom corner X coordinate (longitude);

Y1 – geofence zone left bottom corner Y coordinate (latitude);

X2 or R – geofence zone upper right corner X coordinate (longitude) or radius of circle when Circular zone is used (radius in meters);

Y2 – geofence zone upper right corner Y coordinate (latitude).

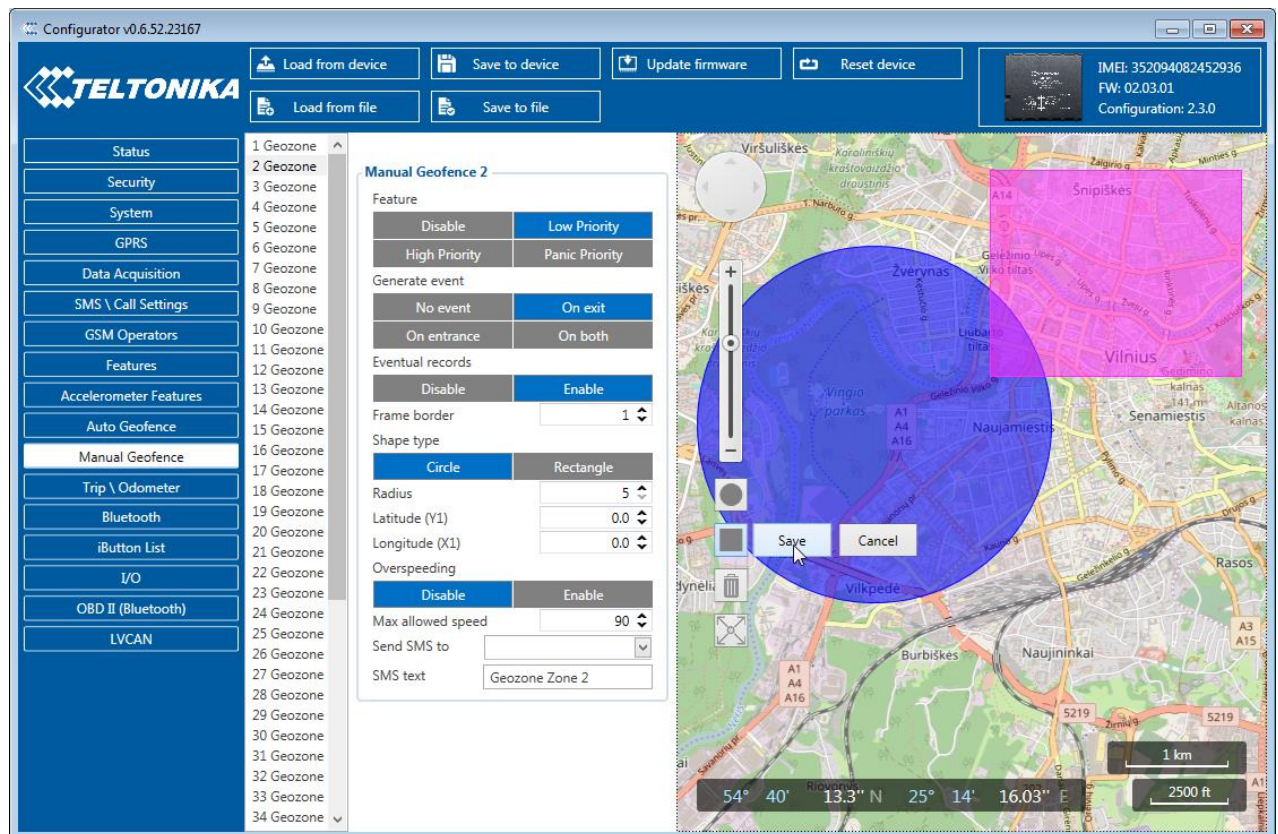

Figure 36 Geofence configuration

5.15 Trip \ Odometer

5.15.1 Trip settings

Trip window offers user to configure Trip feature. If Trip is enabled configuration of parameters are enabled.

Start Speed (km/h) – GPS speed has to be greater than the specified Start Speed in order to detect Trip Start.

Ignition OFF Timeout (s) – timeout to wait if ignition (configured ignition source) was off, to detect Trip stop.

Distance counting mode – Between Records or Continuous can be chosen. For this feature I/O Trip Odometer must be enabled.

If I/O Trip Odometer is enabled and Continuous distance counting variable (Mode) is set to Continuous, **Trip distance** is going to be counted continuously (**from Trip start to Trip stop**). This value is written to I/O Trip Odometer value field. When Trip is over and next Trip begins, Trip Odometer value is reset to zero. When the next trip starts counting continuously starts from the beginning again.

If I/O Trip Odometer is enabled and Continuous Distance Counting variable (Mode) is set “Between Records”, then the distance is going to be counted only between every record made. This value is written to I/O Trip Odometer value field and reset to zero every new record until Trip stops. If later all Odometer values are summed up manually, the user gets the distance driven during the whole period of the Trip.

Trip Settings

Scenario settings

Disable	Low Priority
High Priority	Panic Priority

Eventual Records

Disable	Enable
---------	--------

Mode

Continuous	Between Records
------------	-----------------

Start Speed(km/h)

Ignition OFF Timeout(s)

Send SMS To

SMS text

Figure 37 Trip Settings configuration

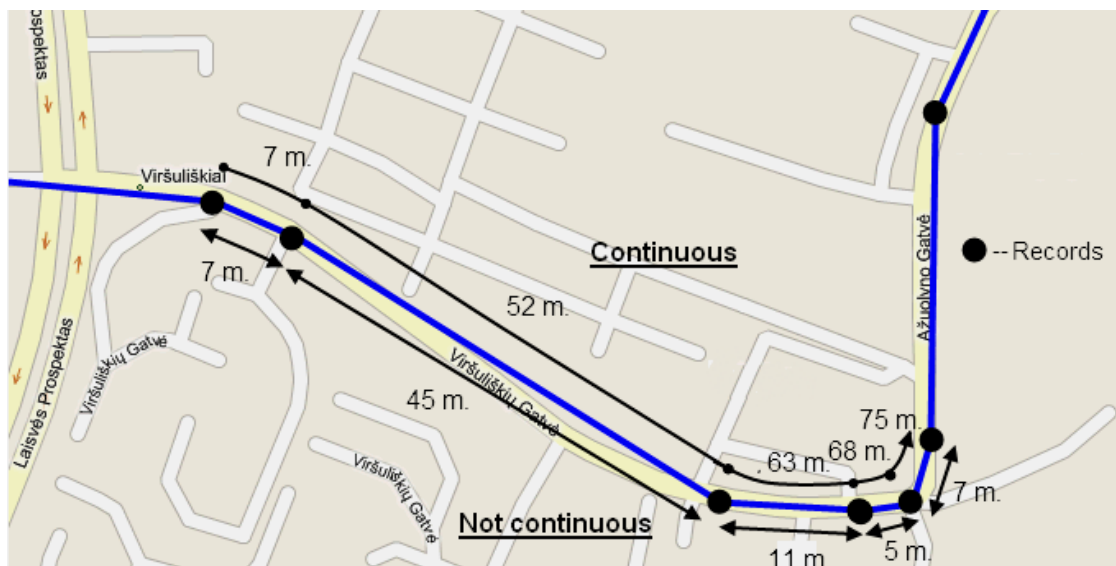

Figure 38 Continuous trip odometer and not continuous trip odometer distance counting example

5.15.2 Advanced Trip Settings

Advanced trip settings allow configure number of Eco Score allowed events in 100 km and enable or disable iButton remember functionality.

Eco Score allowed events – how much ECO events is allowed in 100 km. I/O Eco score must be enabled to get value into server. ECO scoring is differentiated by separate Trips.

There are six ECO evaluation events:

- Harsh acceleration
- Harsh braking
- Harsh cornering
- Over-speeding (count only events with value 1 (start) and ignore value 0(end))
- Excessive Idling (count only events with value 1 (start) and ignore value 0(end))
- High RPM

Eco score value can be from 10 (excellent) to 0.00 (very bad):

- Excellent 8.00 – 10
- Good 6.00 – 7.99
- Not Good 4.00 – 5.99
- Bad 2.00 – 3.99
- Very Bad 0.00 – 1.99

Score evaluation is calculated like this:

$$\text{Eco score} = 10 / ((\text{Total events}) / (\text{Trip distance in km} * \text{Allowed events per km}))$$

$$\text{Allowed events per km} = (\text{Eco Score allowed events} / 100)$$



Note: when Total events < 1, we ignore formula and then Eco score is equal to 10.

If Eco Score allowed events is configured to 0, then Eco score value can have only two values: 0 (when total events > 0) or 10 (when total events = 0).



Note: Score is updated every 1km driven or 5 minutes of trip duration.

Remember iButton functionality. If *Remember iButton ID while trip detected* and *Trip* parameters are enabled, ignition is on and iButton is attached, then FMB1YX remembers iButton ID. iButton ID is saved and sent to server with every record. If new iButton is attached during the trip, FMB1YX remembers new iButton ID. FMB1YX forgets iButton ID after ignition is off and trip ignition off timeout is reached.

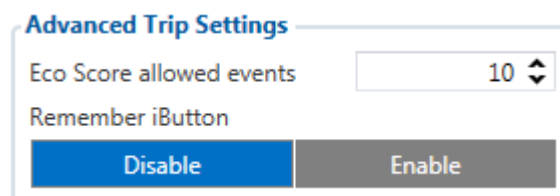

Figure 39 Advanced Trip configuration

5.15.3 Odometer

Calculation Source – choose odometer calculation source of GNSS, OBD or LVCAN.

Odometer Value –sets starting total odometer value.

Odometer

Calculation Source

GNSS	OBD
LVCAN	

Odometer Value(km)

Figure 40 Odometer configuration

5.16 Bluetooth

General

BT Radio

Disable	Enable (hidden)
Enable (visible)	

Local Name

Local PIN

Security Mode

PIN only	PIN + MAC list
MAC list only	None

Auto Connect to External Device

Connection Mode

None	Hands Free
OBDI	Data Link

External MAC

External Name

External PIN

Authorized Devices MAC List

1	
2	
3	
4	
5	

Figure 41 Bluetooth general functionality

5.16.1 General functionality

General functionality configures Bluetooth to work in *slave* mode. This mode allows any external device to connect to FMB1YX.

Parameter *BT Radio* allows user to select if he wants to enable or disable Bluetooth. There are three different scenarios:

1. Disabled – Bluetooth functionality will be disabled.
2. Enable (hidden) – Bluetooth functionality will be enabled, but none of external devices will be able to detect FMB1YX but will be able to connect.
3. Enable (visible) – Bluetooth functionality will be enabled and any external device will be able to detect and connect to FMB1YX.
4. *Local Name* parameter lets user to declare visible name of FMB1YX to external devices.
5. *Local PIN* parameter lets user to configure Bluetooth PIN of FMB1YX device.

FMB1YX Bluetooth has several different *security modes*:

- PIN only – while external device trying to connect to FMB1YX only *Local PIN* will be reacquired to complete connection.
- PIN + MAC list – while external device trying to connect to FMB1YX *Local PIN* and *Authorized Devices MAC List* will be checked. If external device MAC ID is in the list and correct *Local PIN* is entered then connection will be established, else FMB1YX will reject connection.
- MAC list only – while external device trying to connect to FMB1YX only *Authorized Devices MAC List* will be checked. If external device MAC ID is in the list then connection will be established, else FMB1YX will reject connection.
- None – while external device trying to connect to FMB1YX neither *Local PIN* or *Authorized Device MAC list* will be checked.

Auto Connection to External Device functionality

Auto connection functionality configures FMB1YX as *master* device, this allows FMB1YX connect to external device. FMB1YX currently supports these modes:

- None – disables auto connection functionality.
- Hands Free – FMB1YX starts to search external hands free headset. If FMB1YX finds device which matches user defined *External MAC* or *External Name* then FMB1YX will try to pair with that external device. If external device asks for PIN then FMB1YX will send user defined *External PIN*. After successful pairing FMB1YX will connect to paired device.
- OBDII – FMB1YX starts to search external OBDII Bluetooth dongle. If FMB1YX finds device which matches user defined *External MAC* or *External Name* then FMB1YX will try to pair with that external device. If external device asks for PIN then FMB1YX will send user defined *External PIN*. After successful pairing FMB1YX will connect to paired device.
- Data Link – BT Data link mode is enabled by Configurator “Data Link” parameter: When Data Link is configured and FMB has a link with server, paired device could send messages via Bluetooth SPP profile directly to server. Messages will be encoded by codec12.



NOTE: FMB1YX supports ONE connection at a time.

External Name parameter works as substring, this allows user to enter part of the full external device name. For example, if external device name is "*HandsFreeHeadset*" and user enters "*HandsFree*" in *External Name* parameter window then FMB1YX will be allowed to connect to external device named "*HandsFreeHeadset*".

5.16.2 How to connect Bluetooth Hands Free adapter to FMB device

5.16.2.1 Bluetooth settings configuration

These are instructions how to easily prepare Bluetooth Hands Free device connection to FMB device. First we need to configure FMB device Bluetooth settings for proper connection to this hands-free unit. These are required steps:

- Connect FMB device to PC using USB cable.
- Launch **FMB Configurator** and connect to device as shown in **Figure 42** below.

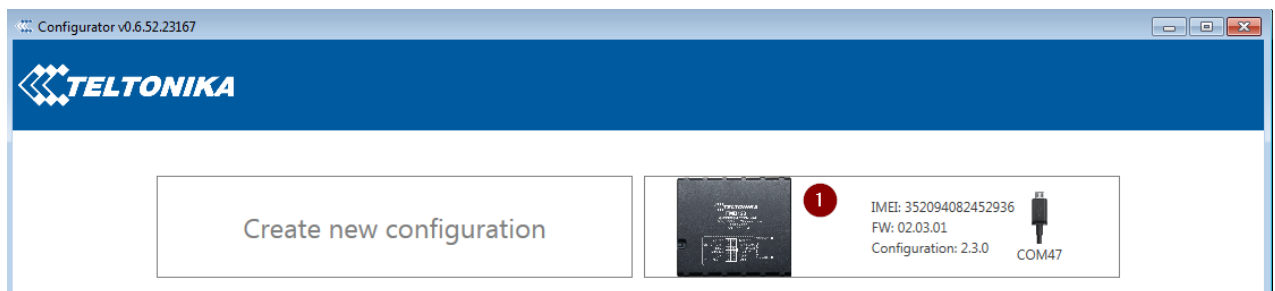

Figure 42 FMB1YX configurator connected devices window

- After successful connection to device wait few moments while device load current configuration, then go to Bluetooth section that visible at **Figure 43**

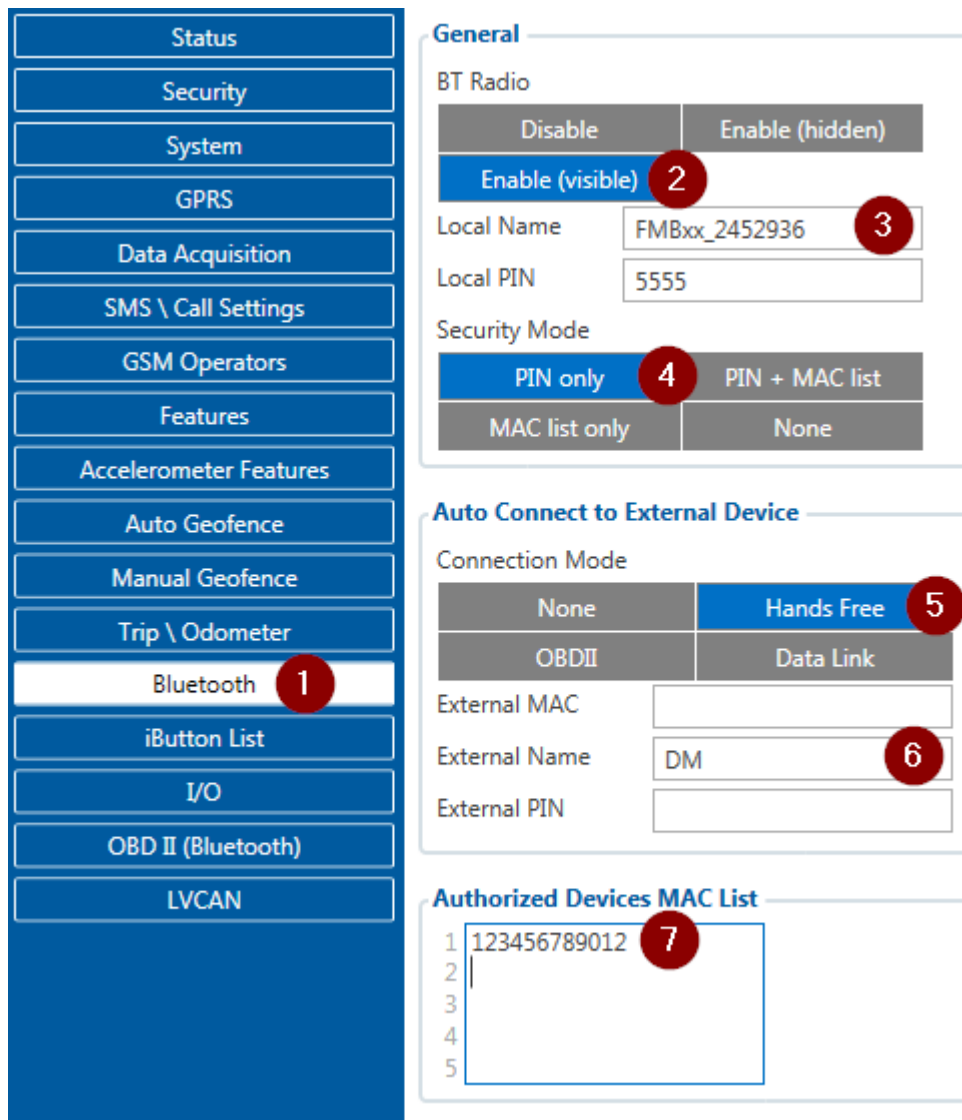

Figure 43 1- Bluetooth settings; 2 - Enable Bluetooth; 3 - Bluetooth local name; 4 - Bluetooth security mode; 5 - Hands Free connection mode; 6 - External Bluetooth device name; 7 - Authorized Devices MAC List;

- When device configuration is loaded press „**Bluetooth**“ settings (**Figure 43** 1 position).
- Turn on BT Radio by pressing „**Enable (visible)**“ (**Figure 43** 2 position). „**Local name**“ (**Figure 43** 3 position) automatically will be “FMB1YX_last 7 imei digits”, you can leave it or type your own name.
- Set Security Mode (**Figure 43** 4 position) to “**PIN only**” or “**None**” (you could select “**PIN + MAC list**” or “**MAC list only**” security mode but in this case you need to type external device MAC address in “**Authorized Devices MAC List**” (**Figure 43** 7 position).
- Set connection mode to “**Hands Free**” (**Figure 43** 5 position).
- Set „**External Name**“ (**Figure 43** 6 position) as your Hands Free device name for proper device identification and connection to it. In this example Hands Free headset name is „DMH10“ but at least 2 characters are needed to recognize it and connect to it. For better and faster adapter identification in network you could

enter a full device name. You could check your Hands Free adapter Bluetooth name by scanning nearby Bluetooth devices using mobile phone or computer with Bluetooth adapter.

- Go to “SMS \ Call Settings” in left menu and set “Incomming Call Action” to “Do Nothing” visible at Figure 44.

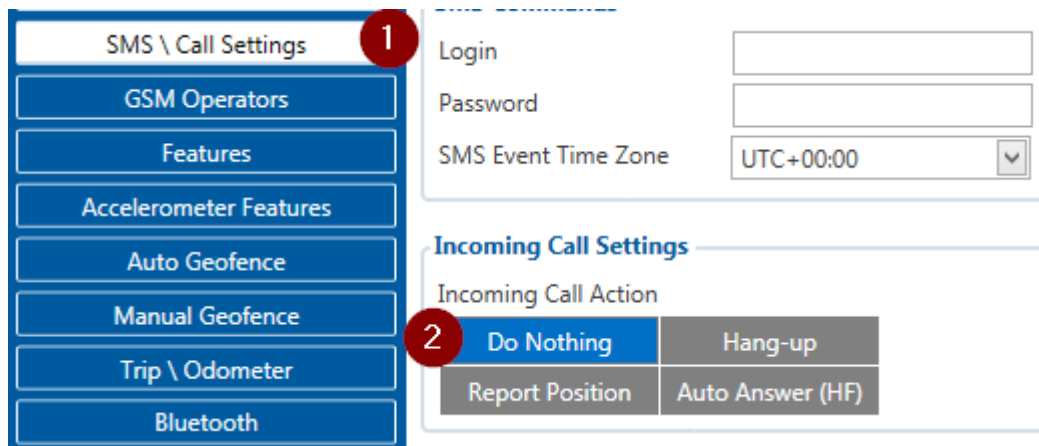

Figure 44 Incoming Call Action settings

- After all these steps press „Save to device“ to save configuration.
- Now you can disconnect FMB device from a configurator.

5.16.2.2 Connecting Bluetooth Hands Free adapter

After this configuration you could connect your Hands Free device to FMB device. Turn on Hands Free device then turn on its Bluetooth connection for pairing following your model instructions¹. Hands Free adapter should make a special sound in ear from speaker or its led identification should change to inform about successful connection². To check if adapter is successfully connected, call to FMB device, Hands Free device should start ringing. If you later restart FMB device it will automatically connect to this adapter.

5.16.3 Device’s log using your mobile phone.

When FMB device starts, automatically Bluetooth is ON too. Take your mobile phone, go to settings>Bluetooth and turn it on. Scan for near by devices, find you device in list, distinguish device by last IMEI numbers on device module. Press pair, wait until device will ask to enter pairing password, type: 5555. Paired device will show up in paired device list. Now download from play store/app store terminal for Bluetooth. E.g BlueTerm. Run app, click find>connect to your paired device. Now we need to send command to FMB1YX from Bluetooth terminal, type: .log:1

Device will respond Debug enabled and FMB1YX log will how up. Do not forget to start save log file to mobile phone.

¹ Hands Free device Bluetooth connection pairing instructions depends on specific model.

² Hands Free device notification about paired Bluetooth connection depends on specific model.

5.16.4 Device debug over Android smartphone

- Scan for visible BT devices using your Android smartphone and connect to your FMB device.

Default FMB BT name: **FMB1YX_last_7_imei_digits**

Default PIN code: **5555**

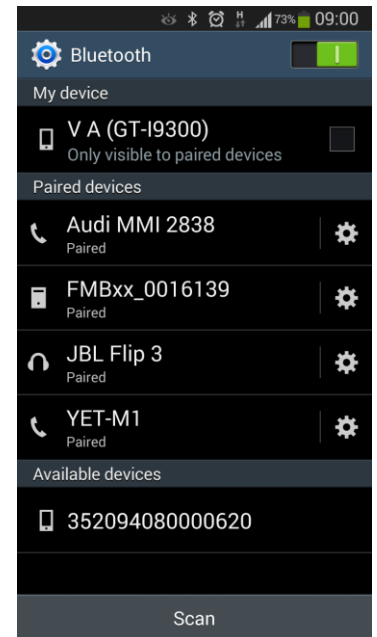

- Download “Bluetooth Terminal” application. You can use link or QR code shown here:

<https://play.google.com/store/apps/details?id=com.hatflabs.btt>



- Run Bluetooth Terminal. In menu press “Connect” button and select paired FMB device. To start log check CR and enter the command in terminal: **.log:1**

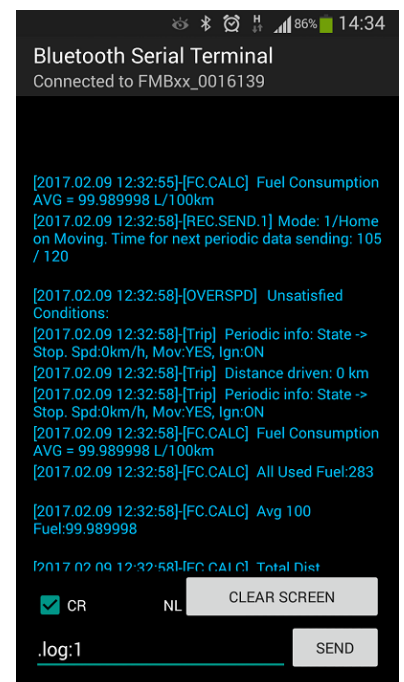

- Wait ~10 minutes and press “Save” button in menu. You will find saved log file in device

folder (My Files/Bluetooth Terminal), select log files and press button Share via Email and send them to the Teltonika support.

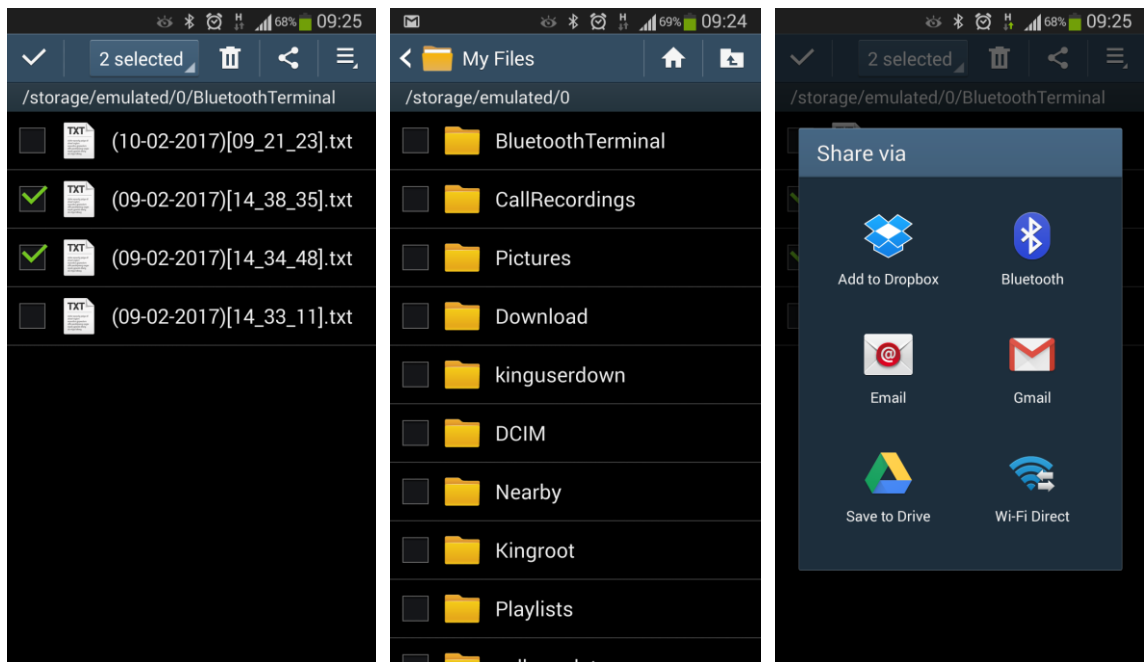

In order to pair FMB device with Android smartphone, make sure that BT radio is enabled (visible) in device configuration. It can be checked via SMS command too:

getparam 800

The answer has to be 2, which means “Enabled and visible”.

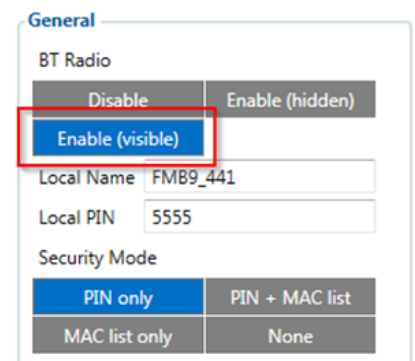

Note: Unfortunately it is not possible to do the same on iPhone, because there is no native SPP Bluetooth profile support in iPhone.

5.16.5 How to connect OBD II Bluetooth Dongle to FMB device

5.16.5.1 Bluetooth settings configuration

These are instructions how to easily prepare Bluetooth Dongle connection to FMB device. First we need to configure FMB device Bluetooth settings for proper connection to this unit. These are required steps:

- Connect FMB device to PC using USB cable.

- Launch **FMB Configurator** and connect to device as shown in **Figure 45** below.

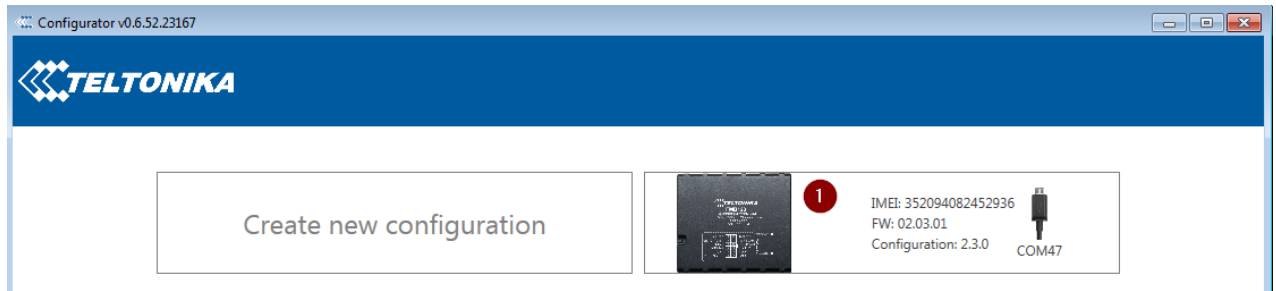

Figure 45 FMB1YX configurator connected devices window

- After successful connection to device wait few moments while device load current configuration, then go to Bluetooth section that visible at **Figure 46**.

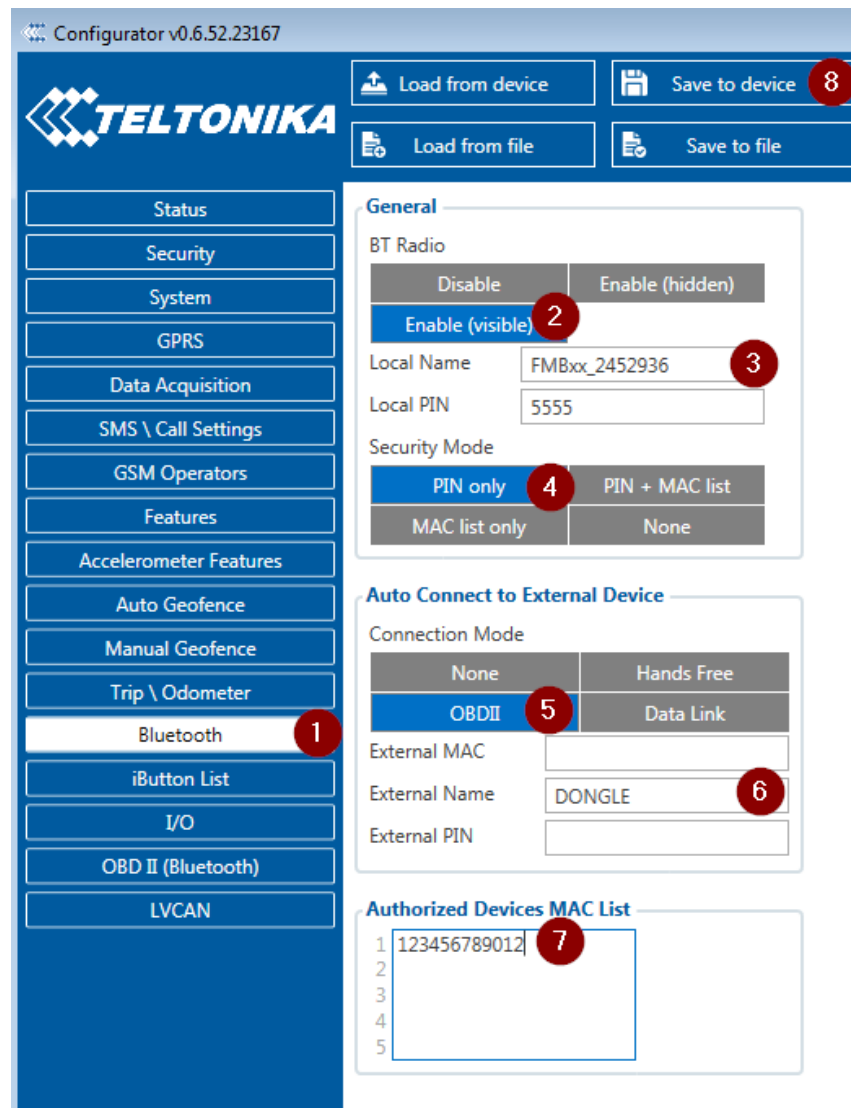

Figure 46 1- Bluetooth settings; 2 - Enable Bluetooth; 3 - Bluetooth local name; 4 - Bluetooth security mode; 5 - OBD II connection mode; 6 - External OBD II Bluetooth device name; 7 - Authorized Devices MAC List; 8 - Save device configuration

- When device configuration is loaded press „Bluetooth“ settings (Figure 46 1 position).
- Turn on BT Radio by pressing „Enable (visible)“ (Figure 46 2 position). “Local name” (Figure 46 3 position) automatically will be “FMB1YX_last 7 imei digits”, you can leave it or type your own name.
- Set Security Mode (Figure 46 4 position) to “PIN only” or “None” (you could select “PIN + MAC list” or “MAC list only” security mode but in this case you need to type external device MAC address in “Authorized Devices MAC List” (Figure 46 7 position).
- Set connection mode to “OBDII” (Figure 46 5 position).
- Set „External Name“ as your Bluetooth OBD II device name for proper device identification and connection to it. In this example OBD II device name is „DONGLE“ but at least 2 characters are needed to recognize it and connect to it. For better and faster adapter identification in network you could enter a full device name. You could check your OBD II adapter Bluetooth name by scanning nearby Bluetooth devices using mobile phone or computer with Bluetooth adapter.
- Go to “OBD II (Bluetooth)” in left menu and select priority and others parameters visible at Figure 47.

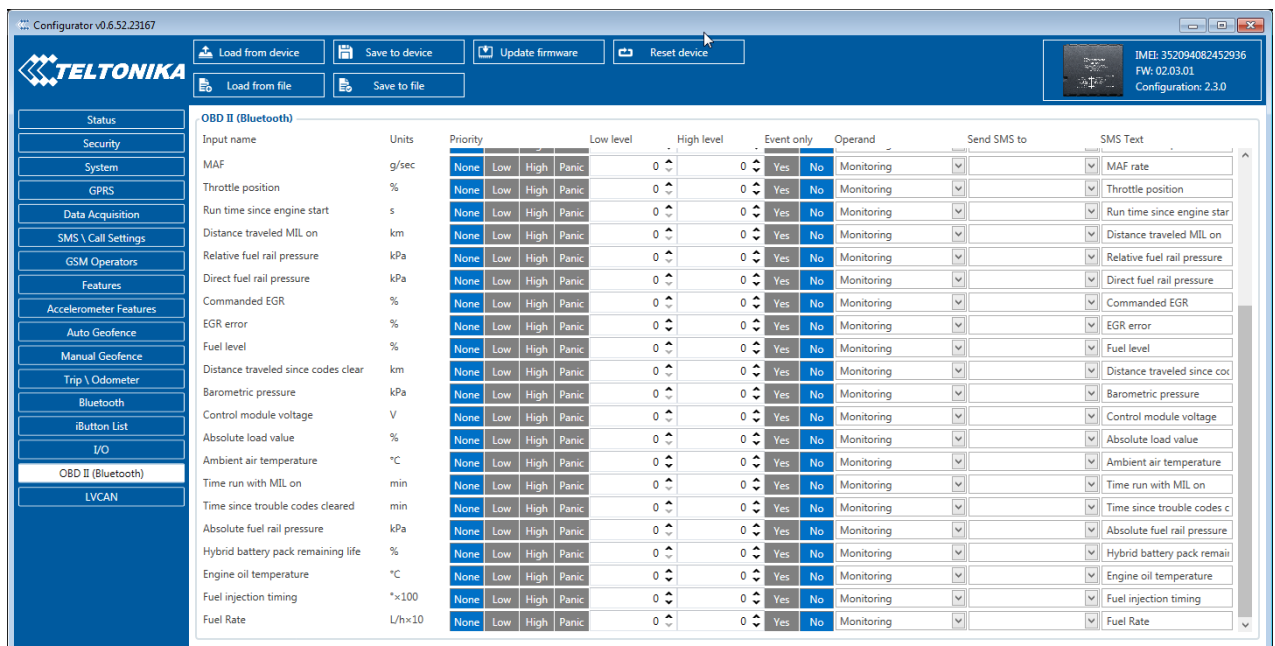

Figure 47 OBD II Bluetooth settings.

- After all these steps press „Save to device“ to save configuration (Figure 46 8 position).
- Now you can disconnect FMB device from a configurator.

5.16.5.2 Connecting to Bluetooth OBD II dongle

After this configuration you could connect your car OBD II dongle to FMB device. Turn on ignition then turn on its Bluetooth connection. For pairing follow your dongle instructions¹. OBD

¹ OBD II dongle Bluetooth connection pairing instructions depends on specific model.

If device notification about paired Bluetooth connection depends on specific model. If you later restart FMB device it will automatically connect to this dongle.

5.16.5.3 Supported Bluetooth OBD II dongles

FMB module works with Bluetooth OBD II dongles which are made with **ELM327** or **STN1110** chips.

Comparison of these chips is presented in **Figure 48**.

	ELM327 v1.4	STN1110
Base microcontroller	PIC18F2580	PIC24HJ128GP502
Architecture	8-bit	16-bit
Processing speed	4 MIPS	40 MIPS
Flash (ROM)	32 KB	128 KB
RAM	1.5 KB	8 KB
Pin count	28	28
Available packages	PDIP, SOIC	PDIP, SOIC, QFN
Supply voltage range	4.5 to 5.5V	3.0 to 3.6V ¹
Supports all OBD-II protocols	yes	yes
ELM327 command set	yes	yes
Enhanced "ST" command set	no	yes
Firmware upgradeable	no	yes
Large OBD message memory buffer	no	yes
Low power mode	yes	yes
Supported UART baud rates	9600 bps to 500 kbps	38 bps to 10 Mbps
OBD message filtering	basic	advanced

Figure 48 ELM327 and STN1110 comparison.

5.17 SMS events

SMS events functionality allows FMB1YX to send a configured SMS when an event is triggered. This event can be triggered by every I/O element.

Then any of the I/O elements is triggered, FMB1YX sends a configured SMS message to a defined phone number. If SMS events is activated, but there are no numbers defined in GSM PreDefined Numbers list (figure 49), then the device will not send any messages.

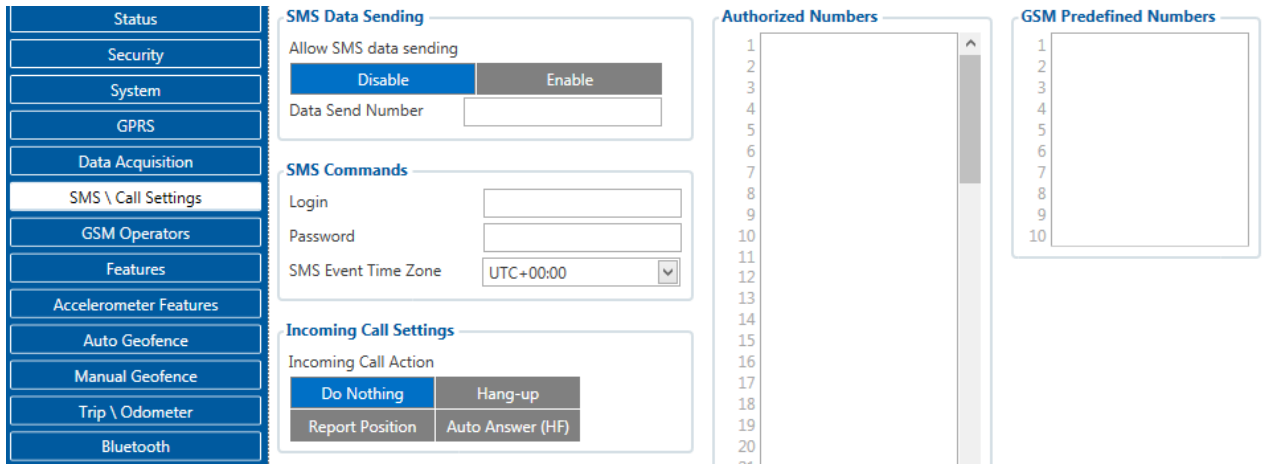

Figure 49 GSM PreDefined Numbers list

The sent SMS messages format is according to:

“Date Time Current Coordinate Event Text”

For example, if FMB1YX is configured to send an SMS, when Ignition reaches High level, with priority High and configured to generate event on both range enter and exit (figure 50), then the sent SMS is:

“2017/06/13 13:52:18 Lon:25.255537 Lat:54.667193 Ignition 1”

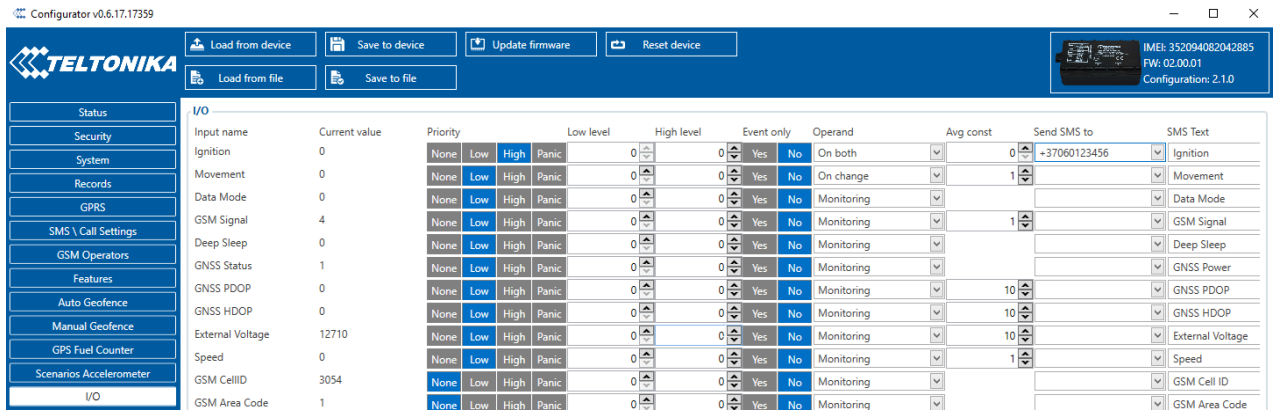

Figure 50 Configured Ignition SMS event

The SMS Text field can be altered and any text can be entered. Maximum message length is 160 symbols (numbers, letters and symbols in ASCII, except for comma “,”).

ATTENTION!



If FMB1YX is in Deep Sleep mode and SMS event occurs with LOW priority (which does not wake up FMB1YX), then the device does not send the message. It is saved in device memory until it wakes up from Deep Sleep mode and GSM modem starts working normally. After it wakes up, all the messages that are saved in memory will be sent, but keep in mind that only 10 messages can be saved in memory – all other messages will not be saved, until there is room in device memory.

5.18 iButton List

iButton list is used to enter authorized iButton ID codes, which are used to authenticate driver in Immobilizer scenario and deactivate Auto Geofencing zone.

iButton number must be entered full into iButton List (16 symbols in hexadecimal format), if iButton will be entered shorter that 16 symbols it will not be saved into device.

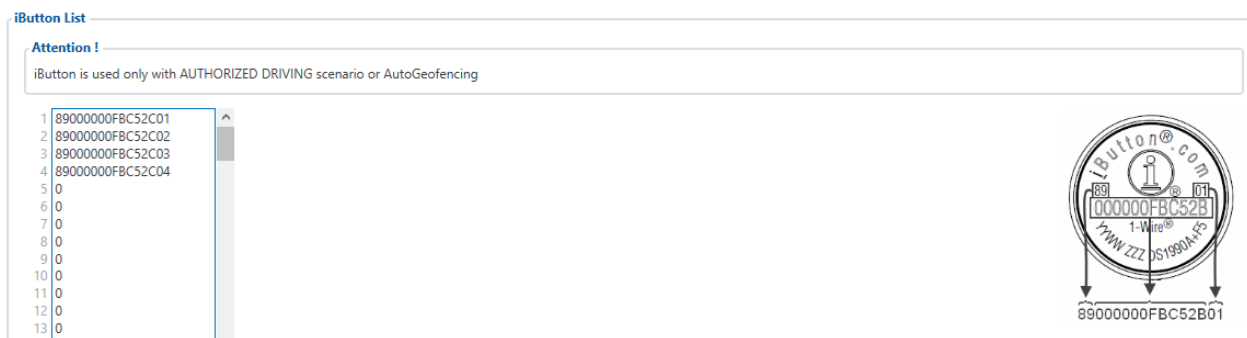

Figure 51 iButton List

5.19 I/O settings

When no I/O element is enabled, AVL packet comes with GNSS information only. After enabling I/O element(s) AVL packet along with GNSS information contains current value(s) of enabled I/O element.

Current value – if device is connected to configurator all current I/O values are displayed in this column.

Priority field – allows enabling I/O element and set them priority so it is added to the data packet and is sent to the server. By default 12 I/O elements with low priority are enabled: Ignition, Movement, Data Mode, GSM Signal, Sleep mode, GNSS Status, GNSS PDOP, GNSS HDOP, External Voltage, Speed, Battery Voltage and Battery Current. Priority (AVL packet priority) can be Low, High or Panic. All records made by FMB1YX are regular. Regular packets are sent as Low priority records. When low priority event is triggered, FMB1YX makes additional record with indication that the reason for that was I/O element change (depends from Operand configuration). When High priority is selected, module makes additional record with high priority flag and sends event packet immediately to the server by GPRS. Panic priority triggers same actions as high priority, but if GPRS fails, it sends AVL packet using SMS data sending mode if **SMS data sending is enabled and data send number is written in SMS \ Call Settings**.

High and Low levels – define I/O value range. If I/O value enters or exits this range, FMB1YX generates event. “Operand” parameter defines when to generate event: On Exit, On Entrance, On Both, On Hysteresis and On Delta Change.

Event only - when selected NO, I/O element status value will be appeared in each AVL record, and when selected YES, I/O element status value will be appended only to eventual records.

Operand – defines when event is send:

5.19.1 Operand On Exit

Record is generated when actual value input increases and becomes higher than high level or decreases and become lower than low level.

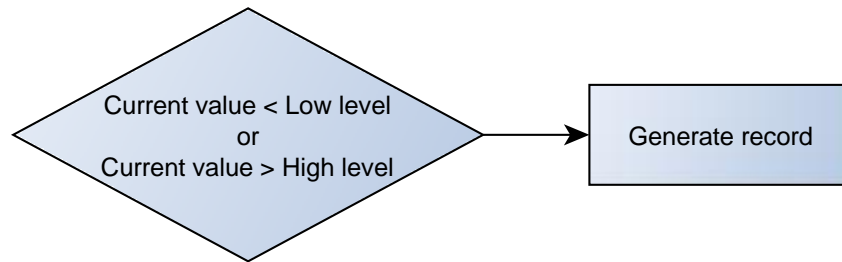

Figure 52 On Exit operand logic

5.19.2 Operand On Entrance

Record is generated when actual value input increases or decreases and becomes between high and low level values.

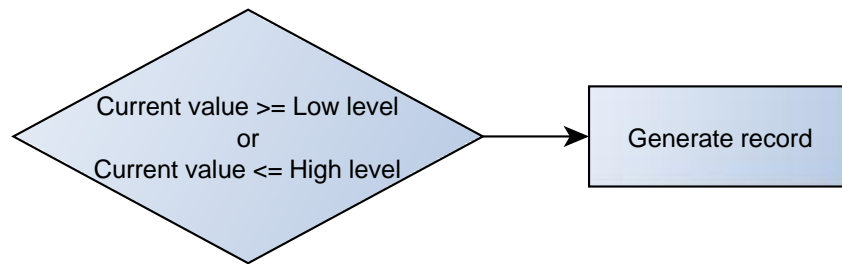

Figure 53 On Entrance operand logic

5.19.3 Operand On Both

Record is generated by both (On Exit and On Entrance) operands logic at same time.

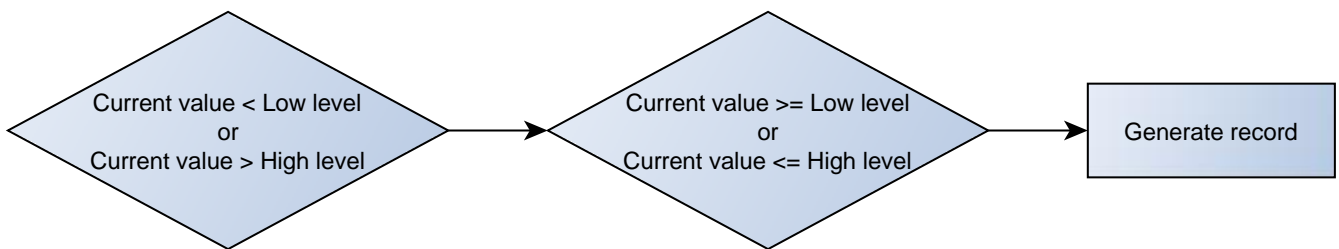

Figure 54 On Both operand logic

5.19.4 Operand Monitoring

No event at all. Values are recorded only when other trigger have worked.

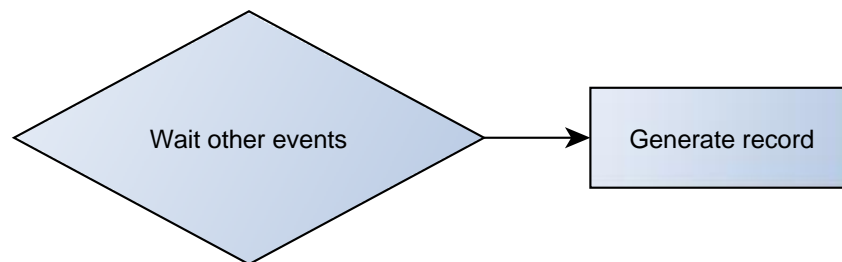

Figure 55 Monitoring operand logic

5.19.5 Operand On Hysteresis

Record is generated when actual value input increases from lower than low value to higher than high level value or decreasing from higher than high level value to lower than low level.

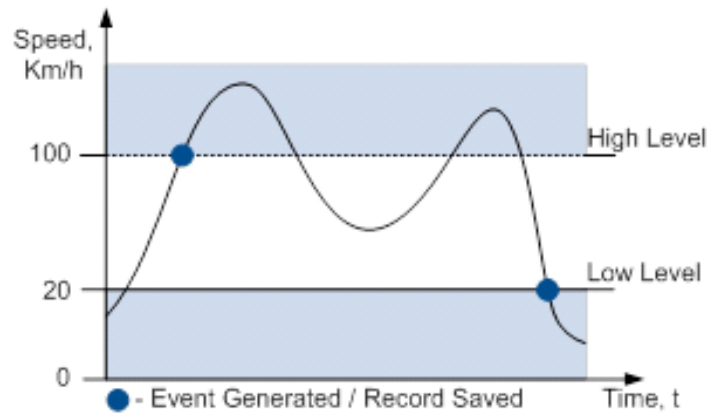

Figure 56 Hysteresis operand logic

5.19.6 Operand On Change

Record is generated when value changes.

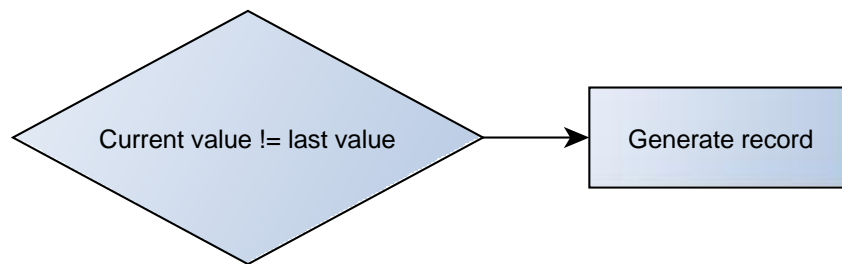

Figure 57 On change operand logic

5.19.7 Operand On Delta Change

Record is generated when value changes and absolute value of last value minus actual input value becomes equal or higher than high level value.

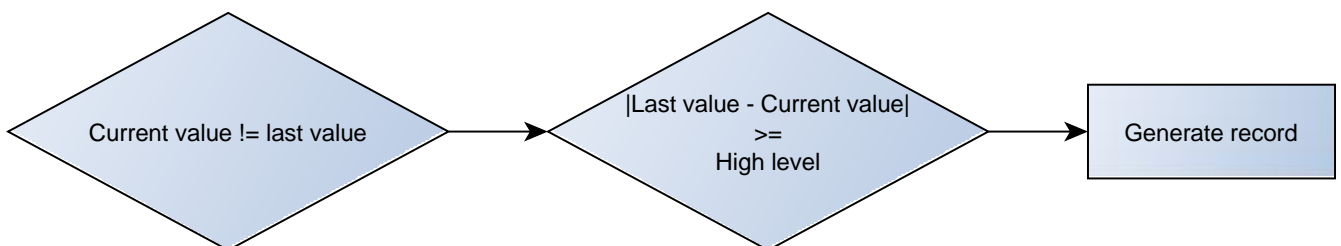

Figure 58 On Delta Change operand logic

5.19.8 Avg const (Averaging parameter description)

If avg const value is 10, new value must be present for 1 second to register change to new value. Internally sampling is done every 40ms, so 25 samples are taken in second. To

configure 5 seconds averaging multiply 10 by 5 yielding 50. The same logic works even if device is in deep sleep mode.

Averaging follows RC exponential curves, see image bellow:

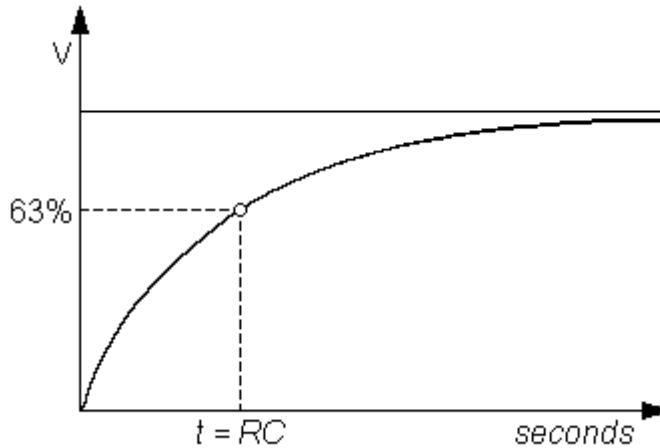

Figure 59 Averaging counting explanation

For Boolean values 5τ , values is used, that means value change is taken when new values is averaged to more then 99.3%.

5.19.9 OBD II (Bluetooth) and LVCAN I/O elements

In OBD II (Bluetooth) column are shown I/O elements which information can be obtained from OBD II Bluetooth dongle connected to FMB1YX device and in LVCAN column are shown I/O elements which information can be obtained from LV-CAN200 or ALL-CAN300 connected to FMB1YX device. All I/O configuration is the same as described in [5.17 chapter \(I/O settings\)](#), except OBD II (Bluetooth) I/O element don't have averaging constant parameter.

Detailed description about LVAN I/O element configuration described in [8.5 chapter \(FMB1YX ALL-CAN300 and LV-CAN200 parameters configuration\)](#).

5.19.10 FMB125 RS232\RS485 parameters configuration¹

FMB125 device supports RS232 and RS485 serial communication transmission of data standards and can be configured to work in different RS232/RS485 modes. More information about each mode in [8 chapter \(RS232 and RS485\)](#).

5.19.10.1 External UART working mode

FMB125 supports RS232 and RS485 modes. Only one mode may be selected for work at one time:

- Disable - Disable RS232/RS485 functionality;
- RS232 - Select RS232 functionality;
- RS485 - Select RS485 functionality;

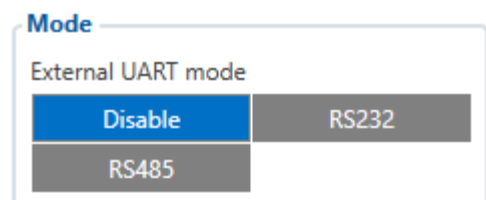

Figure 60 RS232 \ RS485 external UART working mode

¹ Only support FMB125 device

5.19.10.2 RS232 working mode

RS232 support several modes:

- Log Mode – suitable for debugging/logging;
- NMEA – NMEA logs are sent via RS232 or RS485;
- LLS – LLS sensors support;
- LCD – external LCD support;
- RFID HID – RFID card reader support;
- RFID MF7 - RFID card reader support;
- Garmin FMI – Garmin support;
- TCP ASCII – for routing any input string from external device to server¹;
- TCP Binary – for routing any binary input data from external device to server².

5.19.10.3 RS232 Baudrate and parity

Every RS232 mode support different baudrates, but each mode has its own default baudrate value. Default baudrate values for each RS232 working mode are provided in table 14. Also, default parity options are provided in table 14.

RS232	
Mode	
Log Mode	NMEA
LLS	LCD
RFID HID	RFID MF7
Garmin FMI	TCP Ascii
TCP Binary	
Baudrate	
Default	1200
2400	9600
14400	19200
38400	57600
115200	
Parity	
Default	None
Odd	Even

Figure 61 RS232 configurable parameters

¹ For more information, please contact your sales manager.

² For more information, please contact your sales manager.

Table 14. Default Baudrate and Parity by RS232/RS485 working Mode

Mode	RS232 default Baudrate	RS485 default Baudrate	Default Parity (RS232 only)
Log Mode	115200	115200	None
NMEA	115200	115200	None
LLS	19200	19200	None
LCD	57600	-	None
RFID HID	57600	-	None
RFID MF7	9600	-	None
Garmin FMI	9600	-	None
TCP ASCII	115200	57600	None
TCP Binary	115200	57600	None

5.19.10.4 RS232 TCP Binary mode settings

RS232 TCP Binary Mode has additional configurable parameters for advanced data filtering.

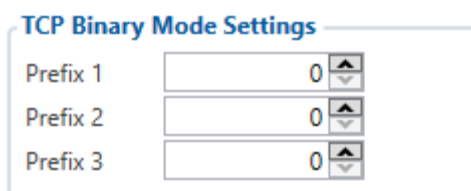

Figure 62 RS232 TCP Binary mode settings

5.19.10.5 RS232 Garmin Mode settings

Garmin FMI mode has additional filtering capabilities. It is possible to filter Ping and Unicode packets. If Ping filter will be enabled, then Ping packets will be blocked. If Unicode filter will be enabled, then Unicode packets will not be sent to server. Both filters may be enabled for simultaneous work.

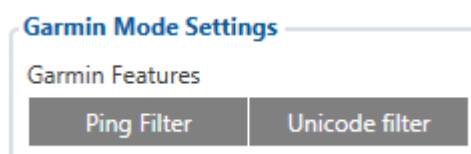

Figure 63 RS232 Garmin Mode settings

5.19.10.6 RS485 working mode

RS485 support several modes:

- Log Mode – suitable for debugging/logging;
- NMEA – NMEA logs are sent via RS232 or RS485;
- LLS – LLS sensors support;
- TCP ASCII – for routing any input string from external device to server;

- TCP Binary – for routing any binary input data from external device to server.

5.19.10.7 RS485 Baudrate

Every RS485 mode support different baudrates, but each mode has its own default baudrate value. Default baudrate values for each RS485 working mode are provided in table 14.

RS485	
Mode	
Log Mode	NMEA
LLS	TCP Ascii
TCP Binary	
Baudrate	
Default	1200
2400	9600
14400	19200
38400	57600
115200	

Figure 64 RS485 configurable parameters

5.19.10.8 RS485 LLS Sensors

LLS addresses may be configured for 5 LLS sensors. If at least one LLS sensor is connected to FMB125 when configuring device with configurator LLS sensor ID will be entered automatically.

RS485 LLS Sensors	
LLS 1 Address	0
LLS 2 Address	0
LLS 3 Address	0
LLS 4 Address	0
LLS 5 Address	0

Figure 65 RS485 five LLS Sensors address selection window.

6 RS232 and RS485¹

6.1 RS485 Interface

RS485 supports only Half Duplex communication. It means that at the same time you can't send/receive Data.

¹ Only support FMB125 device

When activated RS485 driver chip draws constant 30mA current.
 When Entering Sleep or Deep sleep, Chip will be powered off too.
 FMB125 RS485 Pins connection diagram are shown on the Figure 66:

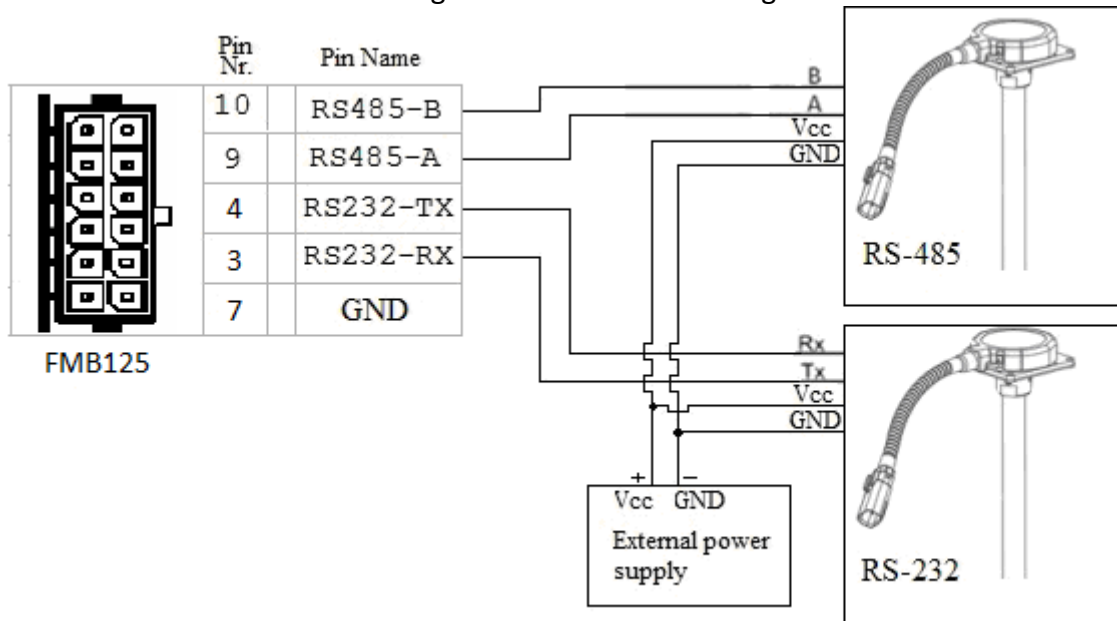

Figure 66 connection block diagram

6.2 RS485 modes

In Configurator windows select RS232/RS485 window where is RS485 Settings (more information about available RS232/RS485 parameters configuration in [5.19.10 FMB125 RS232\RS485 parameters configuration](#) chapter).

6.2.1 RS485 transmit (FMB log) mode

RS-485 works in transmit mode, it prints FM log. It won't respond to commands.

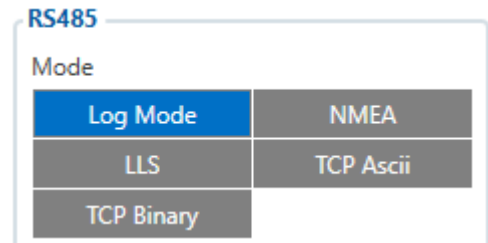

Figure 67 RS485 FMB Log Mode configuration

6.2.2 RS485 transmit (GNSS NMEA) mode

RS-485 works in transmit mode, it prints GNSS NMEA log. It won't respond to commands.

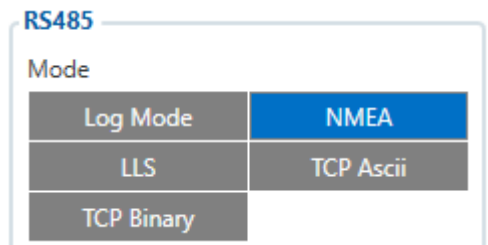

Figure 68 RS485 GNSS NMEA Mode configuration

6.2.3 RS485 receive (LLS) mode

The mode supports up to five LLS fuel level sensors. Baud rate must be 19200. LLS have receiver id. LLS mode configuration shown in Figure 69.

6.2.4 RS485 TCP (ASCII, Binary) mode

In TCP ASCII mode link with external device using text messages can be established.

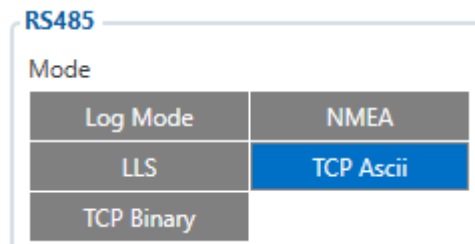

Figure 70 RS485 TCP Ascii Mode configuration

TCP Binary mode is the same as above but binary messages will be accepted.

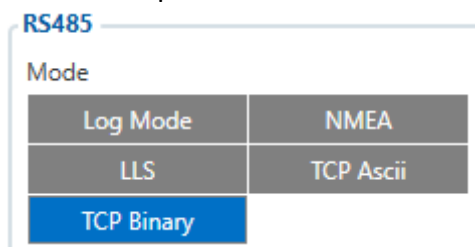

Figure 71 RS485 TCP Binary Mode configuration

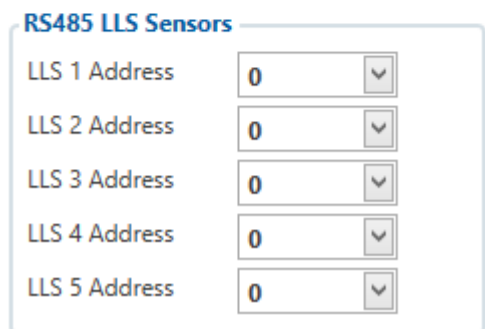
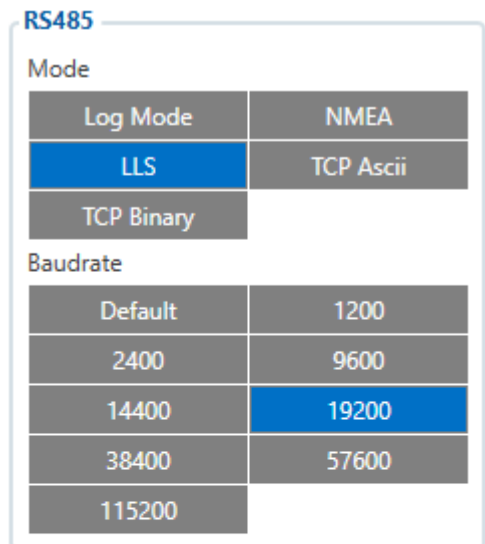

Figure 69 RS485 LLS Mode configuration

6.3 RS232 Interface

RS-232 supports Full Duplex communication. It means that at the same time you can send/receive Data, because it uses separate lines for transmitting and receiving data.

Most of the modes are the same as RS-485.

FMB125 RS232 pins connection diagram are shown on the Figure 66.

6.4 RS232 modes

In Configurator windows select RS232/RS485 window where is RS232 Settings (more information about available RS232/RS485 parameters configuration in [5.19.10 FMB125 RS232\RS485 parameters configuration](#) chapter).

Most of the modes are the same as RS-485. Same modes are: log mode, NMEA, LLS, TCP Ascii and TCP Binary.

In RS232 LLS mode only one LLS fuel level sensor can be connected.

6.4.1 RS232 LCD mode

In this mode you can communicate with server through terminal. Link between FM and server has to be established for this functionality to work.

RS232

Mode

Log Mode	NMEA
LLS	LCD
RFID HID	RFID MF7
Garmin FMI	TCP Ascii
TCP Binary	

Baudrate

Default	1200
2400	9600
14400	19200
38400	57600
115200	

Parity

Default	None
Odd	Even

Figure 72 RS232 LCD Mode configuration

6.4.2 RS232 RFID HID/RFID MF7 mode

The difference between RFID Mode and RFID MF7 Mode is that in RFID Mode FMB125 understands RFID messages that are in hexadecimal format and RFID MF7 Mode understands messages that are in decimal format. For example:

RFID Mode message – “\$aa\$02\$03\$04\$17\$89\$00\$01”

RFID MF7 Mode message – “1213141519”

The chosen mode has to correspond to the RFID reader’s mode. What type of RFID is sent to FMB125 depends on the reader.

For more information about RFID ID’s and devices, please contact to your local sales representative.

RS232

Mode

Log Mode	NMEA
LLS	LCD
RFID HID	RFID MF7
Garmin FMI	TCP Ascii
TCP Binary	

Figure 73 RS232 RFID HID Mode configuration

RS232

Mode

Log Mode	NMEA
LLS	LCD
RFID HID	RFID MF7
Garmin FMI	TCP Ascii
TCP Binary	

Figure 74 RS232 RFID MF7 Mode configuration

6.4.3 RS232 GARMIN mode

Garmin provides a Fleet Management Interface Tool Kit which connected to FMB125 enables the driver to have a "screen" in their vehicle for real-time navigation, messaging, and job dispatch capabilities to help them be more efficient.

RS232

Mode

Log Mode	NMEA
LLS	LCD
RFID HID	RFID MF7
Garmin FMI	TCP Ascii
TCP Binary	

Figure 75 RS232 Garmin FMI Mode configuration

Garmin Mode Settings

Garmin Features

Ping Filter	Unicode filter
-------------	----------------

Figure 76 RS232 Garmin Mode Settings configuration

FMB125 and Garmin operational scheme is shown in Figure 77 below:

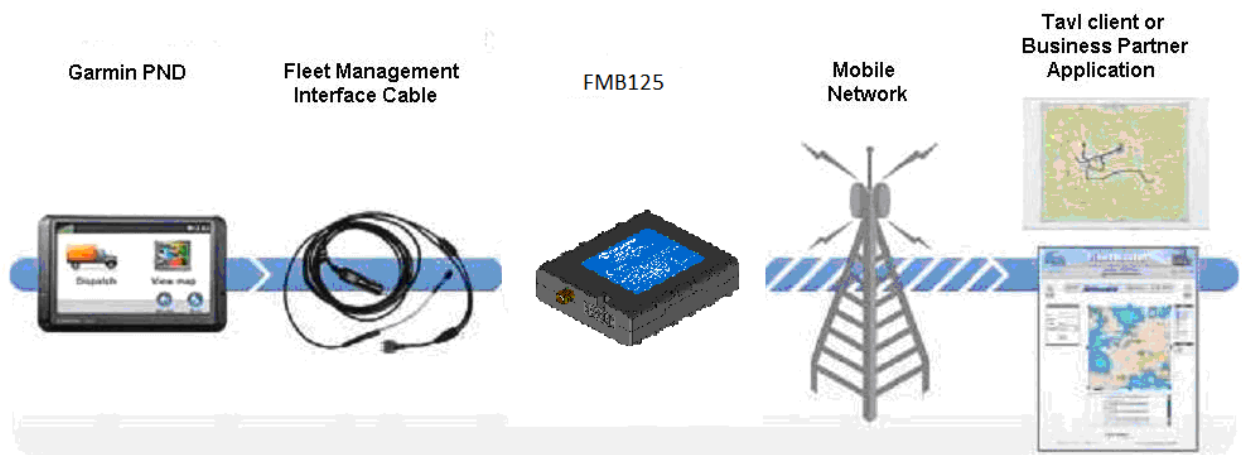

Figure 77 FMB125+Garmin operational scheme

6.5 *Garmin protocols*

The following is a list of protocols supported and the corresponding feature/benefit. FMB125 can fully support Fleet Management Interface (FMI) versions up to 2.1. Other or higher versions may be supported, but Teltonika is not responsible for the changes made by Garmin, which may affect the work of FMB125 and Garmin products. For more information about Garmin products and FMI versions, please go to <http://www8.garmin.com/solutions/pnd/supportedproducts.jsp>. Notice that some Garmin products use different connection cables than others.

6.5.1 **Standard protocols**

Text Message Protocol:

- Allows text messages sent to device to be displayed in "inbox" on unit.
- Garmin can provide confirmation that message was read.
- Garmin can also provide a yes/no box below the text of the message to enable a simple quick response.
- Messages can be up to 199 characters in length.
- Messages can also be generated from device and sent to dispatch/office.
- Messages received will be notified to driver through a pop-up alert on Garmin screen.
- Garmin provides a "virtual keyboard" on device through a touch-screen format for all text communication.

Stop (Destination) Protocol:

- Garmin can display a list of Stops/Jobs reported to the device in a separate icon called "My Stops".
- Driver has ability to navigate directly to Stop from list.
- Garmin can provide status on current Stop in progress.
- Is driver stopped at location?
- How far has Driver progressed through the list of Stops?
- Garmin can also provide confirmation that driver has received a particular Stop, read the details, or deleted it from list.
- Can provide confirmation that a Stop has been completed.

Estimated Time of Arrival Protocol:

- Dispatcher/office can request the ETA of the current stop/job in progress.
- Garmin will notify the actual time of arrival as well as distance remaining to stop.

Auto-Arrival at Stop Protocol:

- This feature is used to tell the Garmin PND to automatically detect that it has arrived at a Stop and then to prompt the driver if they would like to mark the Stop as done and begin navigating to next Stop on the list.
- Auto-arrival can be determined by how long the unit is stopped close to the destination (in the event driver has to park and walk) or by how close the unit needs to be to the destination before the Auto-arrival feature is activated.

Data Deletion Protocol:

- Dispatch/office has the ability to wipe clean the data on the Garmin PND.
- Clean up messages in inbox/remove stops.

6.5.2 Enhanced protocols

Canned Responses/Messages:

- Fleet managers can communicate by sending up to 200 "canned" responses from server to be stored directly on Garmin devices.
- Up to 50 of these canned responses can be utilized for any given scenarios.
- Drivers can store up to 120 canned messages, eliminating the need to type while driving.

Status Protocol:

- Up-to-the-minute communications that allow drivers to automatically send status updates.
- Driver's units can store up to sixteen status indicators such as start/stop shift, on/off break, etc.

6.5.3 Supported features on TAVL client application

TAVL client application lets user to use the following features of GARMIN FMI:

1. Text messaging;
2. Destination message;
3. ETA request.

6.5.4 Text messaging

Text messaging feature lets user to communicate with driver (user that uses Garmin device) by sending text messages via GPRS.

6.5.5 Destination message

Destination message is used to inform a driver of a new destination. When Garmin device receives a destination message from server it displays it as "Stop" to the driver and also gives the driver ability to start navigating to the "Stop" location. New destination in Tavl client is represented as Geozone so new Geozone (as destination) has to be created first.

6.5.6 ETA request message

ETA (Estimated Time of Arrival) request message is used when user wants to know expected arrival time to currently active destination and distance (in meters) from current object location to currently active destination.

7 FMB1YX with LV-CAN200 and ALL-CAN300 Can Adapters

7.1 Purpose of Can Adapters LV-CAN200 and ALL-CAN30

LV-CAN200 is used to listening data from light vehicles, while ALL-CAN300 is used to listening data from any type of transport: light vehicles, Trucks, busses, agriculture and other special transport. With those adapters FMB1YX device is able to collect and send vehicle data.

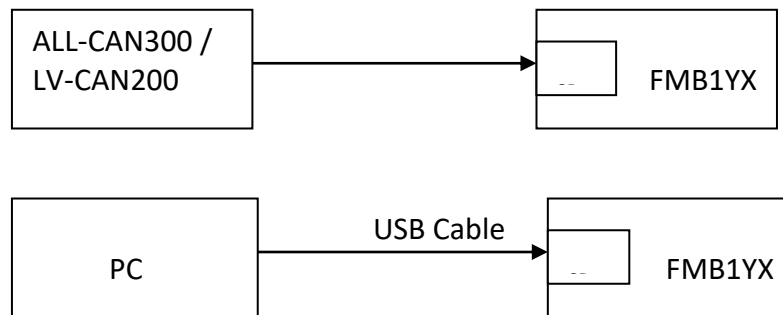

Figure 78 connection block diagram

Table 23. LV-CAN200 and ALL-CAN300 Technical characteristics

PARAMETER	VALUE
Supply voltage	9 to 50V
Power supply current	Average 10mA Max (peak) 100mA
Working temperature	-40..85 °C
Max working humidity	60 % (non condensate)

7.2 LV-CAN200 and ALL-CAN300 program number selection

LV-CAN200 or ALL-CAN300 must be set to program number which depends on vehicle model. **Needed program number is always written on LV-CAN200 or ALL-CAN300 mounting scheme.** Please contact Your Teltonika sales manager to get latest supported vehicle list and mounting scheme for your vehicle, please provide CAR manufacturer, model and year information.

7.2.1 LV-CAN200 and ALL-CAN300 program number configuration via SMS command

LV-CAN200 and ALL-CAN300 program number can be set remotely, using SMS command (more lvcn commands in chapter SMS command list):

lvcansetprog X

X is new program number value.

7.2.2 LV-CAN200 and ALL-CAN300 program number configuration via configurator

LV-CAN200 and ALL-CAN300 program number can be set via configurator: LVCAN -> Program Number. When program number is entered press 'Save to device' button that entered program number saves into FMB1YX.

7.2.3 Selecting LV-CAN200 and ALL-CAN300 program number manually

Steps to set program number:

- Hold SWITCH down till LED starts blinking
- Release the SWITCH

- Then LED starts blinking and counting first digit of program number, (one blink means digit 1, two blink digit 2 etc.)
- To stop counter push SWITCH
- Release the SWITCH, then LED starts blinking and counting second digit of program number
- To stop counter push SWITCH
- Release the SWITCH, then LED starts blinking and counting third digit on program number
- To stop counter push SWITCH
- Release SWITCH, if programming is succeeded LED will blink 10 times



Figure 79 Adapter signaling led

7.3 SIMPLE-CAN - contactless CAN-BUS reader

SIMPLE-CAN is contactless adapter used to read vehicle CAN data with LV-CAN200, ALL-CAN300. If LV-CAN200 or ALL-CAN300 connection requires two CAN lines to get all data, then you need two SIMPLE-CAN readers

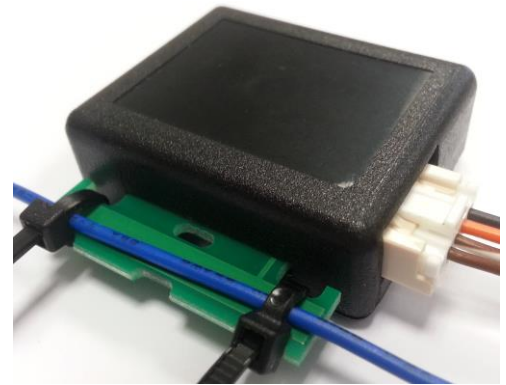

Figure 80 Teltonika SIMPLE-CAN

TECHNICAL DETAILS

- Power supply voltage 9-63 V
- Power supply current:

Mode	12V	24V
Active	8.3 mA	4.3 mA
Standby	1.6 mA	0.91 mA

- CAN-BUS speeds from 33,33 to 500 kb/s
- Automatically sets CAN Low, CAN High polarity
- Automatically adjusts signal level and speed

SIMPLE-CAN works in the **listening mode only**, so not all the data available on the CAN-BUS may be received using this solution. **The device automatically sets CAN L/H polarity**, but the calibration has to be always executed during installation process. Connection of previously calibrated unit to another car needs new calibration because the reader **automatically adjusts signal level and speed** to different CAN-BUSes. The device also **automatically adapts** to the found **noise level**.

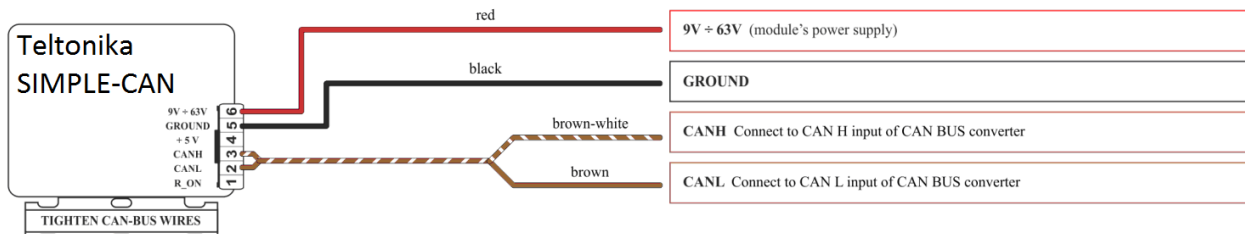

Figure 81 Teltonika SIMPLE-CAN pinout

After power supply connecting, LED shines continuously. It means that device waits for calibration. **Calibration process** has to be carried out when CAN-BUS twisted pair is tightened on SIMPLE-CAN and when the ignition is ON. Please press the switch shortly and wait for the LED

to start blinking every 1 second. Automatic calibration process takes up to 10 seconds depending on the vehicle's model. Correct calibration process is confirmed by LED's every 2 seconds blink (when the CAN-BUS is active). When the CAN-BUS enters sleep mode, SIMPLE-CAN device does it also and takes 1,6mA/12V. In the sleep mode LED does not shine. If after calibration process LED shines continuously, it means that device is not calibrated yet, CAN-BUS transmission has failed or ignition during calibration was not ON.

7.4 Connecting FMB1YX Can adapters ALL-CAN300 and LV-CAN200

Connect LV-CAN200/ ALL-CAN300 Pin 5 to FMB1YX Pin 12 (INPUT 5) LV-CAN200/ ALL-CAN300 Pin 6 to FMB1YX Pin 6 (INPUT 6), connect Light Vehicles Can adapter to other end of the cable.

Connect Light Vehicles Can adapter Pin 1 and Pin 2 to cars CAN bus. CAN interface location of the supported light vehicle is described on mounting scheme.

Connect car power supply lines to Pin 3 positive, Pin 4 Negative.

Pins 9, 10 connections are optional it depends on exact car model.

For exact pinout see sticker on Light Vehicles Can adapter.

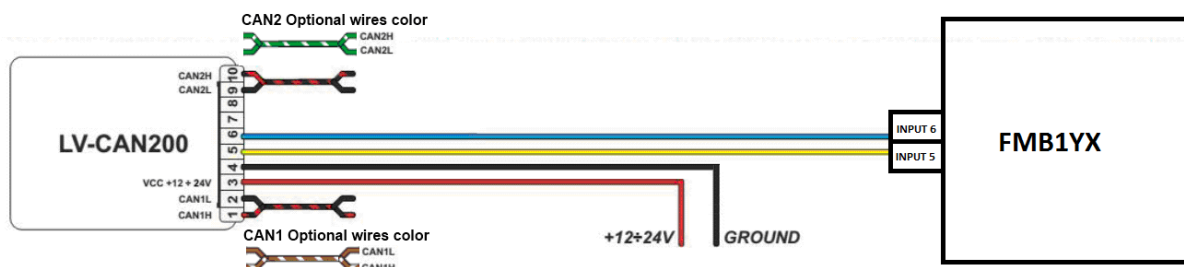

Figure 82 LV-CAN200 Adapter connection cable pinout

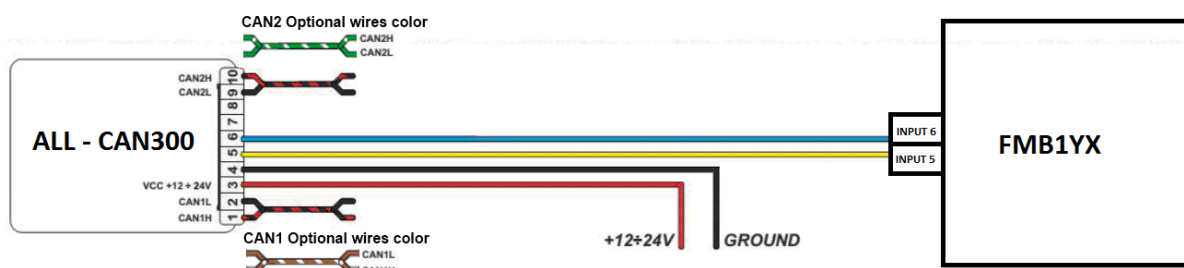

Figure 83 ALL-CAN300 Adapter connection cable pinout



Attention! For detailed connection diagram of adapter to light vehicle please contact Teltonika, LTD sales representative and provide CAR manufacturer, model and year information.



Attention! Do not swap CAN L and CAN H lines.
Do not swap power supply lines. Make sure that voltage do not exceeds 30V. Power supply lines should be connected at the end of installation work.

7.5 FMB1YX ALL-CAN300 and LV-CAN200 parameters configuration

Because FMB1YX have LV-CAN200 / ALL-CAN300 RX and TX in its own pinout device configuration can be performed via micro-USB when CAN adapter are connected in vehicle.

When FMB1YX are connected to configurator and at the same moment to LV-CAN200 or ALL-CAN300, in configurator LVCAN section user can see all information that is received from vehicle, that data are marked with green background color. Information in this section is automaticali refreshed. CAN bus data which can be read from your car is shown in “Light or ALL Vehicles Can adapter supported cars” document.

The LVCAN I/O element can be configured like any other I/O element in FMB1YX configurator.

When using offline configuration metod user can select which CAN data will be red from LV-CAN200 or ALL-CAN300 and directly sent to server without connection to adapter. Please note that parameters depend on vehicle manufacturer and vehicle model. Please for further information check “Light and All Vehicles Can adapter supported cars” document.

All information about I/O element parameters description is in chapter 5.17 I/O settings.

All LV-CAN200/ALL-CAN300 I/O parameters configuration settings are described in “FMB1YX Protocols” document, except ALL-CAN300 bitmasks, they are described in table 24 below.

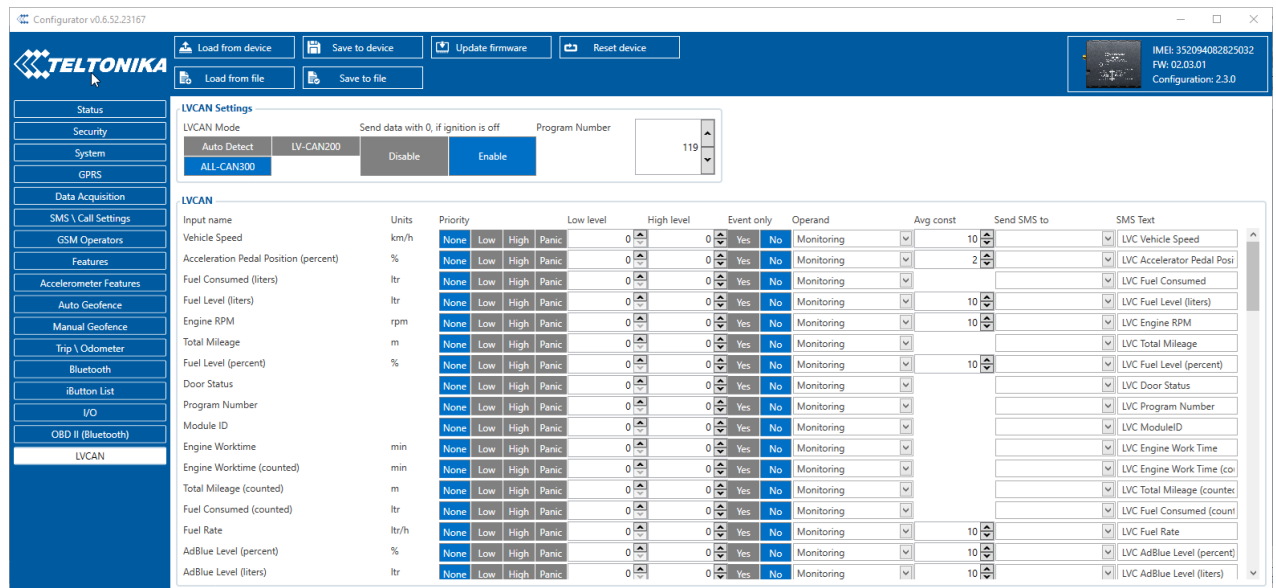

Figure 84 Configurator example

Table 24. ALLCAN300 IO element values bitmasks

Property Name	Size, Bytes	Value bitmasks
Control state flags	4	<p>Byte0 (LSB):</p> <ul style="list-style-type: none"> 0x01 – STOP 0x02 – Oil pressure / level 0x04 – Coolant liquid temperature / level 0x08 – Handbrake system 0x10 – Battery charging 0x20 – AIRBAG <p>Byte1:</p> <ul style="list-style-type: none"> 0x01 – CHECK ENGINE

Property Name	Size, Bytes	Value bitmasks
		<p> 0x02 – Lights failure 0x04 – Low tire pressure 0x08 – Wear of brake pads 0x10 – Warning 0x20 – ABS 0x40 – Low Fuel Byte2: 0x01 – ESP 0x02 – Glow plug indicator 0x04 – FAP 0x08 – Electronics pressure control 0x10 – Parking lights 0x20 – Dipped headlights 0x40 – Full beam headlights Byte3: 0x40 – Passenger's seat belt 0x80 – Driver's seat belt </p>
Agricultural machinery flags	8	<p> Byte0 (LSB): 0x01 – Mowing 0x02 – Grain release from hopper 0x04 – First front hydraulic turned on 0x08 – Rear Power Take-Off turned on Byte1: 0x01 – Excessive play under the threshing drum 0x02 – Grain tank is open 0x04 – 100% of Grain tank 0x08 – 70% of Grain tank 0x10 – Drain filter in hydraulic system of drive cylinders is plugged 0x20 – Pressure filter of drive cylinders hydraulic system is plugged 0x40 – Alarm oil level in oil tank 0x80 – Pressure filter of brakes hydraulic system is plugged Byte2: 0x01 – Oil filter of engine is plugged 0x02 – Fuel filter is plugged 0x04 – Air filter is plugged 0x08 – Alarm oil temperature in hydraulic system of chasis 0x10 – Alarm oil temperature in hydraulic system of drive cylinders 0x20 – Alarm oil pressure in engine 0x40 – Alarm coolant level 0x80 – Overflow chamber of hydraulic unit Byte3: </p>

Property Name	Size, Bytes	Value bitmasks
		<p> 0x01 – Unloader drive is ON. Unloading tube pivot is in idle position 0x02 – No operator! 0x04 – Straw walker is plugged 0x08 – Water in fuel 0x10 – Cleaning fan RPM 0x20 – Trashing drum RPM Byte4: 0x02 – Low water level in the tank 0x04 – First rear hydraulic turned on 0x08 – Standalone engine working 0x10 – Right joystick moved right 0x20 – Right joystick moved left 0x40 – Right joystick moved front 0x80 – Right joystick moved back Byte5: 0x01 – Brushes turned on 0x02 – Water supply turned on 0x04 – Vacuum cleaner 0x08 – Unloading from the hopper 0x10 – High Pressure washer (Karcher) 0x20 – Salt (sand) disperser ON 0x40 – Low salt (sand) level Byte6: 0x01 – Second front hydraulic turned on 0x02 – Third front hydraulic turned on 0x04 – Fourth front hydraulic turned on 0x08 – Second rear hydraulic turned on 0x10 – Third rear hydraulic turned on 0x20 – Fourth rear hydraulic turned on 0x40 – Front three-point Hitch turned on 0x80 – Rear three-point Hitch turned on Byte7: 0x01 – Left joystick moved right 0x02 – Left joystick moved left 0x04 – Left joystick moved front 0x08 – Left joystick moved back 0x10 – Front Power Take-Off turned on </p>
Security state flags	8	<p> Byte0 (LSB): 0x20 – bit appears when any operate button in car was put 0x40 – bit appears when immobilizer is in service mode 0x80 – immobiliser, bit appears during introduction of a programmed sequence of keys in the car. Byte1: 0x01 – the key is in ignition lock 0x02 – ignition on 0x04 – dynamic ignition on </p>

Property Name	Size, Bytes	Value bitmasks
		<p>0x08 – webasto 0x20 – car closed by factory's remote control 0x40 – factory-installed alarm system is actuated (is in panic mode) 0x80 – factory-installed alarm system is emulated by module</p> <p>Byte2: 0x01 – parking activated (automatic gearbox) 0x10 – handbrake is actuated (information available only with ignition on) 0x20 – footbrake is actuated (information available only with ignition on) 0x40 – engine is working (information available only when the ignition on) 0x80 – revers is on</p> <p>Byte3: 0x01 – Front left door opened 0x02 – Front right door opened 0x04 – Rear left door opened 0x08 – Rear right door opened 0x10 – engine cover opened 0x20 – trunk door opened</p> <p>Byte4: 0x01 – car was closed by the factory's remote control 0x02 – car was opened by the factory's remote control 0x03 – trunk cover was opened by the factory's remote control 0x04 – module has sent a rearming signal 0x05 – car was closed three times by the factory's remote control - High nibble (mask 0xF0 bit) 0x80 – CAN module goes to sleep mode</p>
Tachograph driver card presence	1	<p>0x00 – No driver card 0x01 – Driver1 card presence 0x02 – Driver2 card presence 0x03 – Driver1 and driver2 cards present</p>
Driver 1 states	1	<p>0xX0 – break/rest 0xX1 – availability 0xX2 – work 0xX3 – driving 0x0X – no time-related warning detected 0x1X – limit #1: 15 min before 4 1/2 h 0x2X – limit #2: 4 1/2 h reached (continuous driving time exceeded) 0x3X – limit #3: 15 minutes before optional warning 1 0x4X – limit #4: optional warning 1 reached</p>
Driver 2 states	1	

Property Name	Size, Bytes	Value bitmasks
		0x5X – limit #5: 15 min before optional warning 0x6X – limit #6: optional warning 2 reached

7.6 Send data with 0, if ignition is off

Depending on LV-CAN200 / ALL-CAN300 I/O parameters and ignition status, FMB1YX can send *locked* (last known) LV-CAN200 / ALL-CAN300 I/O parameters values, *reset* values (set to 0) and *active* (real time) parameters values. When ignition is off, LV-CAN200 / ALL-CAN300 I/O parameters values sent to server are:

LV-CAN200 / ALL-CAN300 I/O element	Status
Vehicle Speed	reset
Accelerator pedal position	reset
Total fuel used	lock
Fuel level (liters)	lock
Engine RPM	reset
Total mileage	lock
Fuel level (proc.)	lock
Program number	lock
Module ID	lock
Engine Work Time	lock
Engine Work Time (counted)	lock
Total Mileage (counted)	lock
Fuel Consumed (counted)	lock
Fuel Rate	reset
AdBlue Level (percent)	lock
AdBlue Level (liters)	lock
Engine Load	reset
Engine Temperature	active
Axle 1 Load	lock
Axle 2 Load	lock
Axle 3 Load	lock
Axle 4 Load	lock
Axle 5 Load	lock
Control State Flags	active
Agricultural Machinery Flags	active
Harvesting Time	lock
Area of Harvest	reset
Mowing Efficiency	active
Grain Mown Volume	active
Grain Moisture	active
Harvesting Drum RPM	reset
Gap Under Harvesting Drum	active
Security State Flags	active

LV-CAN200 / ALL-CAN300 I/O element	Status
Tachograph Total Vehicle Distance	lock
Trip Distance	reset
Tachograph Vehicle Speed	reset
Tachograph Driver Card Presence	active
Driver1 States	active
Driver2 States	active
Driver1 Continuous Driving Time	active
Driver2 Continuous Driving Time	active
Driver1 Cumulative Break Time	active
Driver2 Cumulative Break Time	active
Driver1 Selected Activity Duration	active
Driver2 Selected Activity Duration	active
Driver1 Cumulative Driving Time	active
Driver2 Cumulative Driving Time	active

8 SMS/GPRS COMMAND LIST¹

All commands are case sensitive. While FMB1YX operates in Deep Sleep mode and user tries to send SMS/GPRS message it cannot arrive to FMB1YX device, because GSM/GPRS module is disabled most of the time (wake up depends on Send Period parameter). FMB1YX will receive the SMS/GPRS when it wakes up (exits deep sleep mode).

While FMB1YX is in GPS Sleep or Online Deep Sleep mode and user tries to send SMS/GPRS message it will arrive to device, because GSM module is enabled.

8.1 SMS/GPRS command list

Table 15. Common SMS/GPRS commands

Command	Description	Response
getinfo	Device runtime system information	Yes
getver	Returns code version, device IMEI, modem app version, RTC time, Init time, Uptime and BT MAC address.	Yes
getstatus	Modem Status information	Yes
getgps	Current GPS data, date and time.	Yes
getio	Readout analog input,digital input and output	Yes
ggps	Returns location information with Google maps link	Yes
readio #	Returns IO status, # AVL ID	Yes
cpureset	Resets device	No

¹ GPRS commands require Codec 12 protocol

Command	Description	Response
getparam #	Returns selected parameter value, # param ID	Yes
setparam #:#	Sets selected parameter value. 1.# - first ID value.	Yes
setparam #:#;#:#;...	2.# - New first Parameter Value 3.# - second ID value. 4.# - New second Parameter Value 5.# - third ID value. 6.# - New third Parameter Value SMS command of limited to 160 characters.	
flush #,#,#,#,#,#	Redirects device to other server. 1.# - IMEI 2.# - APN 3.# - LOGIN 4.# - PASS 5.# - IP 6.# - PORT 7.# - MODE (0-TCP/1-UDP)	Yes
countrecs	Returns records number	Yes
deleterecords	Delete all records from SD card	Yes
FMB120 and FMB122: setdigout ## Y1 Y2 FMB125: setdigout # Y	Set digital output 1.# – 0 or 1 (0 - OFF or 1 – ON) for DOUT1 2.# – 0 or 1 (0 - OFF or 1 – ON) for DOUT2 Y1 – timeout value for DOUT1 if needed (in seconds) Y2 – timeout value for DOUT2 if needed (in seconds)	Yes
battery	Returns battery state info.	Yes
wdlog	Returns all information about “watch dogs” restarts.	Yes
defaultcfg	Load default configuration.	Yes
setkey # #	Add new or change current configuration keyword. If device is locked, keyword cannot be changed 1.# - old keyword (if adding new keyword space (view chapter 5.1.2)) 2.# - new keyword	Yes
delkey #	Remove existing keyword. (If device is locked, keyword cannot be changed) # - old keyword	Yes
bbread #	Return black box information (HEX value of event ID and HEX value of custom data field (optional)). 1.# - returns entered number of latest events. When # is omitted the latest events are packed to single SMS.	Yes
bbinfo #	Return same information as bbread command but additional all events timestamp is written in HEX. 1.# - returns entered number of latest events. When # is omitted the latest events are packed to single SMS.	Yes

Command	Description	Response
sdformat	Format SD card.	Yes

Table 16. SMS commands related to features

Command	Description	Response
fc_reset	Resets fuel consumption parameters	Yes
towingreact	Towing reactivation	Yes
auto_calibrate	Calibrate position if car accelerate straight to > 30 km/h for 5 sec.	Yes
position_info	Indicates what axis is set to the front of the car.	Yes
calibrate	Zero out accelerometer axis (vehicle speed must be 0 km/h.)	Yes
odokset:#	Set total odometer value. # - new odometer value in km	Yes
odoget	Display current odometer value	Yes

Table 17. SMS commands related to Bluetooth

Command	Description	Response
btgetlist #	Returns requested Bluetooth list. # - 0,1 or 2 (0 – Discovered, 1 – Paired, 2 – Connected)	Yes
btscan	Starts Bluetooth scan.	Yes
btvisible #	Sets Bluetooth to visible with TMO. # - visibility TMO (from 1 to 255 seconds).	Yes
btrelease #	Disconnects from current device and pauses auto connect functionality for TMO # - none or TMO (from 1 to 255 seconds).	Yes
btunpair #	Unpair Bluetooth device. # - all, BT address (all – unpair all devices, BT address – unpair only specified MAC address).	Yes

Table 18. SMS commands related to OBD

Command	Description	Response
obdinfo	If connected with Bluetooth OBD dongle displays all available information from OBD.	Yes
faultcodes	If connected with Bluetooth OBD dongle display all visible fault codes.	Yes
cleardtc	Clears all vehicle stored fault codes.	No
getvin	Get vehicle VIN code, if OBD dongle is connected.	Yes

Table 19. SMS commands related to LV-CAN200/ALL-CAN300

Command	Description	Response
lvcansetprog #	Set program number to LV-CAN200/ ALL-CAN300 that is connected to FMB1YX. # three digits number that identity vehicle.	Yes
lvcansimpletacho #	Add or remove simpletacho start byte.	No

Command	Description	Response
	# - 0 or 1 (0 – don't add start byte, 1 – add start byte).	
lvcangetprog	Get program number from LV-CAN200/ ALL-CAN300 that is connected to FMB1YX.	Yes
lvcangetinfo	Get information about connected LV-CAN200/ ALL-CAN300	Yes
lvcanclear #	Clear Total Mileage (counted), Engine Work Time (counted), Fuel Consumed (counted) parameters values. # - parameter (0 – Engine work time (counted), 1 – Fuel Consumed (counted), 2 – Vehicle Mileage (counted)).	Yes
allcanmode	Turn on ALL-CAN300 mode	Yes
lvcanmode	Turn on LV-CAN200 mode	Yes
lvcanfaultcodes	Read DTC fault codes	Yes

Parameter ID consists of 3 or 5 digits. Detailed list of parameters and IDs can be found in chapter 7 PARAMETER LIST.

Example: **'username password setparam 2001:wap'** will change configured APN.

Example: **'username password setparam 2001:wap;2002:user;2003:pass'** will change configured APN name, APN username and APN password. SMS command of limited to 160 characters.

Example: **'username password setdigout 10 60'** will set digital output ON for 60s.

8.1.1 getinfo

Response details	Description
RTC	RTC Time
Init	Device initialization time
UpTime	Total up time (in seconds)
PWR	Last restart reason
RST	Total restarts count
GPS	GPS receiver state. 0 – OFF, 1 – ON without fix, 2 – ON with fix, 3 – In sleep mode.
SAT	Average satellites
TTFF	Time To First Fix
TTLF	Time To Last Fix
NOGPS	How much time no GPS fix (h:min)
SR	Number of Sent Records
FG	Failed GPRS counter
FL	Failed link counter
SMS	Sent SMS Counter
REC	Records Found – number of records in the memory.
MD	Data Mode state. 0 – Home and Stop, 1 – Home and Moving, 2 – Roaming and Stop, 3 – Roaming and Moving, 4 – Unknown and Stop, 5 – Unknown and Moving

Example: "RTC:2017/6/16 7:13 Init:2017/6/16 5:44 UpTime:4744s PWR:PwrVoltage RST:0 GPS:1 SAT:0 TTF:0 TTL:0 NOGPS: 1:18 SR:0 FG:200 FL:0 SMS:3 REC:42 MD:1".

8.1.2 getver

Response details	Description
Ver	Firmware version
GPS	Version of GPS module
Hw	Version of hardware
Mod	HW version modification
IMEI	Device IMEI
Init	Device initialization time
Uptime	Total up time (in seconds)
BT	Device MAC address

Example: "Ver:02.00.01_06 GPS:AXN_3.80_3333_16070400,0000,, Hw:FMB1YX Mod:4 IMEI:352094082042885 Init: 2017-6-16 5:54 Uptime: 16574 BT:31F5BFE66261".

8.1.3 getstatus

Response details	Description
Data Link	Indicate module connection to server at the moment: 0 – Not connected, 1 – connected
GPRS	Indicate if GPRS is available at the moment
Phone	Voice Call status: 0 – ready, 1 – unavailable, 2 – unknown, 3 –ringing, 4 – call in progress, 5 – asleep
SIM	SIM Status: 0-ready, 1-pin, 2-puk, 3-pin2, 4-puk2
OP	Connected to GSM Operator: numerical id of operator
Signal	GSM Signal Quality [0-5]
NewSMS	Indicate if new message received
Roaming	0 – Home Network, 1 – roaming
SMSFull	SMS storage is full? 0 – ok, 1 – SMS storage full
LAC	GSM Tower Location Area Code
Cell ID	GSM Tower Cell ID Code

Example: "Data Link: 0 GPRS: 1 Phone: 0 SIM: 0 OP: 24602 Signal: 5 NewSMS: 0 Roaming: 0 SMSFull: 0 LAC: 1 Cell ID: 3055".

8.1.4 getgps

Response details	Description
GPS	Indicates valid (1) or invalid (0) Gps data
Sat	Count of currently available satellites
Lat	Latitude (Last good Latitude)
Long	Longitude (Last good Longitude)
Alt	Altitude
Speed	Ground speed, km/h
Dir	Ground direction, degrees
Date	Current date
Time	Current GMT time

Example: "GPS:1 Sat:0 Lat:54.666042 Long:25.225031 Alt:0 Speed:0 Dir:0 Date: 2017/6/16 Time: 12:52:30".

8.1.5 getio

Response details	Description
DI1	Digital input 1 value
DI2 ¹	Digital input 2 value
DI3 ²	Digital input 3 value
AIN1	Analog input 1 value
AIN2 ³	Analog input 2 value
DO1	Digital output 1 value
DO2 ⁴	Digital output 2 value

Example: "DI1:0 DI2:0 DI3:0 AIN1:0 AIN2:0 DO1:0 DO2:0".

8.1.6 ggps

Response details	Description
D	Date
T	Time
S	Actual Speed
C	Latitude (Last good Latitude), Longitude (Last good Longitude)
Url	Google Maps Link

Example (if no GNSS FIX): "GPS Data not Available. No GPS signal".

Example: D:17/1/9 T:12:52:30 S:0.00 C:54.666042, 25.225032 Url: <http://maps.google.com/?q=54.666042,25.225032&om=1speed:0>

8.1.7 readio

Response details	Description
ID	I/O element ID
Value	I/O Element value

Example (if wrong ID): "Not supported or not enabled IO element requested".

Example: "Param ID:239 Value:0".

8.1.8 getparam

Read parameter value. ID consists of 3 or 5 digits. A detailed list of parameters and identifiers can be found in this chapter next later.

Example: ,getparam 2001' command will request APN name

Answer: Param ID:2001 Value:wap

8.1.9 setparam

Read parameter value. ID consists of 3 or 5 digits. A detailed list of parameters and identifiers can be found in this chapter next later.

¹ FMB125 don't have Digital input 2

² FMB125 don't have Digital input 3

³ FMB125 don't have Analog input 2

⁴ FMB125 don't have Digital output 2

Example: ,setparam 2001:wap' will change configured APN name

Answer: Param ID:2001 Value:wap2

Example: 'setparam 2001:wap;2002:user;2003:pass' will change configured APN name, APN username and APN password. SMS command of limited to 160 characters.

8.1.10 flush #,#,#,#,#,#

Initiates all data sending by GPRS to specified target server. Comma separated parameters go as numbered:

- 1.# - IMEI
- 2.# - APN
- 3.# - GPRS LOGIN
- 4.# - GPRS PASSWORD
- 5.# - IP
- 6.# - PORT
- 7.# - MODE (0-TCP/1-UDP)

Parameters are separated by comma (no spaces needed). In case you don't need to enter parameter (APN Login/ APN Pass) – do not put space, simply put comma and write next parameter.

Parameters are separated by comma (no spaces needed). In case you don't need to enter parameter (APN Login/ APN Pass) – do not put space, simply put comma and write next parameter.

Example: opa opa flush 353976012555151,banga,,,212.47.99.62,12050,0

Response details	Description
FLUSH SMS Accepted	FLUSH SMS Accepted
# records found on FLASH	Number of records found on FLASH
Minimum Records to Send: #	Number of minimum saved records to send
GPRS Enabled: #	State of the GPRS connection, 0 – disabled; 1 – enabled
Time Sync: #	Indicates time synchronization on the device, 0 – not synchronized; 1 – synchronized

Example: "FLUSH SMS Accepted. 11 records found on FLASH. Minimum Records to Send: 1. GPRS Enabled: 1. Time Sync: 1."

8.1.11 countrecs

Returns currently records number in SD card or device memory.

Example (if more that 100): "more then 100 records found".

Example: "25 records found".

8.1.12 deleterecords

Delete all records from SD card or device memory.

8.1.13 setdigout

Sets digital outputs to ON or OFF state (timeout is valid only when DOUT state is changing from OFF to ON)

Example: 'setdigout 01 30 60' will set DOUT1 to low level (for infinite time) and DOUT2 to high level for 60 seconds,

'setdigout 11' will set DOUT1 and DOUT2 to high level for infinite time.

FMB125 have only one digital output, so only one DOUT must be described in command.

Example: 'setdigout 1 60' will set DOUT1 to high level for 60 seconds.

8.1.14 battery

Response details	Description
BatState	Battery connected (1) or disconnected (0) from device
FSMState	Current battery state
ChargerIC	Battery charging status
ExtV	External Voltage
BatV	Battery voltage
BatI	Battery charging current

Example: "BatState: 1 FSMState: ACTIVE ChargerIC: OFF ExtV: 11796 BatV: 3942 BatI: 0".

8.1.15 fc_reset

Reset GPS fuel consumption value.

Example: "Fuel Consumption parameters reseted".

8.1.16 towingreact

Reactivates Towing Detection to initial state (does not wait for ignition to be OFF). Useful when generated false Towing event and needs reactivation.

8.1.17 odoset:#

Set new total odometer value in km.

Example: "Saved Odometer Value: 5000 km".

8.1.18 odoget

Get total odometer value in km.

Example: "Current Odometer Value:5000 km".

8.1.19 btgetlist

btgetlist command needs argument what list should be printed!

btgetlist 0; device will respond with BT_LIST_Discovered

btgetlist 1; device will respond with all paired devices

btgetlist 2; device will respond with connected bluetooth device



Note: Without argument it is always 0 i.e **BT_LIST_Discovered**
In FW 01.00.23 btgetlist (without args) will not respond (as unknown command).

8.1.20 obdinfo

Response details	Description
LIST of OBD info	Protocol, VIN, AdaptiveTiming value, requested PID counter, OBD application state, available vehicle PIDs, mil status, number of DTCs

Example:

"Prot:0,VIN:N/A,TM:10,CNT:0,ST:OFF,P1:0x0,P2:0x0,P3:0x0,P4:0x0,MIL:0,DTC:0,IDO,Hdr:0,Phy:0"

8.1.21 faultcodes

Response details	Description
LIST	Returns list of fault codes; response when no faults: "No fault codes detected."

Example: "P0100,P0200,P0300,C0300,B0200,U0100"

8.1.22 setkey

"setkey <oldkeyword> <newkeyword>" - Set new or change the keyword. Configuration should be not locked.

Example: New keyword (set):

<name>{space}<pass>{space}setkey{space}{space}<newkeyword>

Change keyword (change):

<name>{space}<pass>{space}setkey{space}<oldkeyword>{space}<newkeyword>

8.1.23 delkey

"delkey <keyword>" - Deletes current keyword. Configuration keyword should be configured and not locked.

Example:

<name>{space}<pass>{space}delkey{space}<keyword>

8.1.24 bbread

describes start offset and is an optional field. # of value 20 means that blackbox data is requested starting from 20th latest event. When # is omitted the latest events are packet to single SMS.

Example: X1:Y1,X2:Y2,...,Xn:Yn, where Xn – HEX value of event ID. Yn – HEX value of custom data field (optional).

8.1.25 bbinfo

describes start offset and is an optional field. # of value 20 means that blackbox data is requested starting from 20th latest event. When # is omitted the latest events are packet to single SMS.

Example: X1-Y1:Z1,X2-Y2:Z2,...,Xn-Yn:Zn, where Xn – timestamp in HEX. Yn – HEX value of event ID. Zn – HEX value of custom data field (optional).

8.1.26 sdformat

Format sd card (deleta all information from SD card).

8.1.27 lvcansetprog

Set program number to LV-CAN200 or ALL-CAN300 which is connected to FMB1YX.

8.1.28 lvcangetprog

Get currently using program number from LV-CAN200 or ALL-CAN300.

8.1.29 lvcangetinfo

Response details	Description
LIST of LV-CAN200 or ALL-CAN300 info	Program number, SW creation date, SW revision, Kern version, Option and its ID, Simple tachometer configuration.

8.1.30 lvcanclear

It is possible to clear Total Mileage (counted), Engine Work Time (counted), Fuel Consumed (counted) parameters with following SMS command.

SMS text: "lvcanclear #"

Possible values of #:

- 0 – Engine work time (counted);
- 1 – Fuel Consumed (counted);
- 2 – Vehicle Mileage (counted);

8.1.31 allcanmode

Turn on ALL-CAN300 mode.

8.1.32 lvcanmode

Turn on LV-CAN200 mode.

8.1.33 lvcanfaultcodes

Possible OK answers:

1. No fault codes detected.
2. 2:C0300,1:P0300,3:B0200,4:U0100"

ALL-CAN300 detected 4 DTC codes:	
- ABS controller	C0300;
- ENGINE controller	P0300;
- SRS controller	B0200;
- TCM controller	U0100

Possible error answers:

1. Ignition is off (DTC reading is not possible);
2. DTC not supported;
3. Communication error;
4. Error – diagnostic computer connected;
5. Error – engine is working;

9 PARAMETER LIST

9.1 System parameters

9.1.1 Sleep Mode (ID=102)

Device has three sleep modes: GPS sleep, Deep Sleep and Online Deep Sleep mode. While sleep is disabled (value 0) module will never enter sleep mode, in sleep mode (value 1) module reduces level of power usage by turning GPS module to sleep, in deep sleep mode (value 2) module turns GPS module to sleep and device is deregistered from network (note, that FMB1YX do not receive SMS while in deep sleep), online Deep Sleep mode (value 3) device works as in Deep Sleep mode, but without deregistering from GSM network. GSM part stays powered, so this increases power consumption. In this mode, device should received/send SMS and make/receive calls. Also not closes GPRS context, if previously opened.

Minimum value	Maximum value	Default value	Goes with (depends on) parameters	Value type
0	3	2	Sleep timeout (ID=103)	Uint8

9.1.2 Sleep timeout (ID=103)

Sleep timeout is time after which FMB1YX goes to GPS sleep, Deep Sleep or Online Deep Sleep if other requirements are met. It is measured in minutes.

Minimum value	Maximum value	Default value	Goes with (depends on) parameters	Value type
1	3000	10	Sleep Mode (ID=102)	Uint8

9.1.3 Movement Source (ID=100)

Device can operate and change its working mode according to motion detection source: ignition (value 0), movement sensor (value 1), GPS (value 2), CAN speed (value 3).

Minimum value	Maximum value	Default value	Goes with (depends on) parameters	Value type
0	3	1	-	Uint8

9.1.4 Static Navigation (ID=106)

When static navigation is enabled, FMB1YX filters out GPS jumps, when it is not moving. When it is disabled, it does not make any changes to collected GPS data.

Minimum value	Maximum value	Default value	Goes with (depends on) parameters	Value type
0	1	1	Static Navigation Settings (ID=112)	Uint8

9.1.5 Analog input value range (ID=111)

Sets AIN measurement range: 0 – 10 V, 0 – 30 V (for now 0 – 10 V range works same as 0 – 30 V range).

Minimum value	Maximum value	Default value	Goes with (depends on) parameters	Value type
0	1	0		Uint8

9.1.6 Static Navigation Settings (ID=112)

Sets static navigation exit (movement) detection sources. 1 – Movement Source, 2 – Ignition Source, 3 – both (Movement or ignition).

Minimum value	Maximum value	Default value	Goes with (depends on) parameters	Value type
1	3	1	Static Navigation (ID=106) Movement Source (ID=100) Ignition settings (ID=101)	Uint8

9.1.7 Saving/Sending without time synchronization (ID=107)

When this feature is enabled (value = 1), then records can be saved and sent to server without time synchronization.

Minimum value	Maximum value	Default value	Goes with (depends on) parameters	Value type
0	1	1		Uint8

9.1.8 GNSS Source (ID=109)

This parameter sets Satellite System, available values:

0 – Undefined	4 – Galileo only	9 – GPS+Beidou	14–GPS+Galileo +Glonass
2 – Glonass only	5 – Galileo+Beidou	10 – GPS+Glonass	15–GPS, Galileo, Glonass and Beidou and not allowed
1– Beidou only	6 – Galileo+Glonass	12 – GPS+Galileo	
3 – Galileo+Beidou	8 – GPS only	13 – GPS+ Galileo + Beidou	

Minimum value	Maximum value	Default value	Goes with (depends on) parameters	Value type
0	15	10		Uint8

9.1.9 Ignition settings (ID=101)

This parameter sets ignition source available values:

1 – Digital Input	5 – Digital Input and Power Voltage	9 – Digital Input and Engine RPM	13 – Digital Input, Power Voltage and Engine RPM
-------------------	--	-------------------------------------	--

2 – Accelerometer	6 – Accelerometer and Power Voltage	10 – Accelerometer and Engine RPM	14 – Accelerometer, Power Voltage and Engine RPM
3 – Digital Input and Accelerometer	7 – Digital Input, Accelerometer and Power voltage	11 – Digital Input, Accelerometer and Engine RPM	15 – Digital Input, Accelerometer, Power voltage and Engine RPM
4 – Power voltage	8 – Engine RPM	12 – Power voltage and Engine RPM	

Minimum value	Maximum value	Default value	Goes with (depends on) parameters	Value type
1	15	4	High voltage level (ID=104) Low voltage level (ID=105) Movement Start Delay(s) (ID=19001) Movement Stop Delay(s) (ID=19002)	Uint8

9.1.10 High voltage level (ID=104)

Sets high level of voltage.

Minimum value	Maximum value	Default value	Goes with (depends on) parameters	Value type
0 (but higher than low level)	30000	30000	Ignition settings (ID=101) Low voltage level (ID=105)	Uint16

9.1.11 Low voltage level (ID=105)

Sets low level of voltage.

Minimum value	Maximum value	Default value	Goes with (depends on) parameters	Value type
0	29999 (but lower than high level)	13200	Ignition settings (ID=101) High voltage level (ID=104)	Uint16

9.1.12 Movement Start Delay(s) (ID=19001)

What Accelerometer Ignition source delay will be after Ignition on.

Minimum value	Maximum value	Default value	Goes with (depends on) parameters	Value type
1	60	1	Ignition settings (ID=101) Movement Stop Delay(s)	Uint8

			(ID=19002)	
--	--	--	------------	--

9.1.13 Movement Stop Delay(s) (ID=19002)

What Accelerometer Ignition source delay will be after Ignition off.

Minimum value	Maximum value	Default value	Goes with (depends on) parameters	Value type
5	60	60	Ignition settings (ID=101) Movement Start Delay(s) (ID=19001)	Uint16

9.1.14 Led indication (ID=108)

Sets led indication: 0 – disabled, 1 – enabled

Minimum value	Maximum value	Default value	Goes with (depends on) parameters	Value type
0	1	1		Uint8

9.1.15 Synchronization settings (ID=900)

Settings used for device internal time synchronization: 0 – GPS only, 1 – NITZ and NTP, 2 – NTP, 3 – NITZ.

Minimum value	Maximum value	Default value	Goes with (depends on) parameters	Value type
0	3	1	NTP Resync (ID=901) NTP server 1 (ID=902) NTP server 2 (ID=903)	Uint8

9.1.16 NTP Resync (ID=901)

Periodical time synchronization. If not zero FMB1YXx will resynchronize time once set period expires.

Minimum value	Maximum value	Default value	Goes with (depends on) parameters	Value type
0	24	0	Synchronization settings (ID=900) NTP server 1 (ID=902) NTP server 2 (ID=903)	Uint8

9.1.17 NTP server 1 (ID=902)

Minimum value	Maximum value	Default value	Goes with (depends on) parameters	Value type
0	55 char string	avl1.teltonika.lt	Synchronization settings (ID=900) NTP Resync (ID=901) NTP server 2 (ID=903)	S8[55]

9.1.18 NTP server 2 (ID=903)

Minimum value	Maximum value	Default value	Goes with (depends on) parameters	Value type
0	55 char string	pool.ntp.org	Synchronization settings (ID=900) NTP Resync (ID=901) NTP server 1 (ID=902)	S8[55]

9.1.19 Battery charge mode (ID=110)

Sets when charging is allowed: 0 – On Need, 1 – After Ignition ON.

Minimum value	Maximum value	Default value	Goes with (depends on) parameters	Value type
0	1	0		Uint8

9.2 GPRS parameters

9.2.1 Sorting (ID=1002)

Record sorting parameter is responsible for record sorting order. Value of 0 arranging data starting from newest, while value of 1 arranging data starting from oldest.

Minimum value	Maximum value	Default value	Goes with (depends on) parameters	Value type
0	1	0	Open Link Timeout (ID=1000) Server Response Timeout (ID=1001)	Uint8

9.2.2 Open Link Timeout (ID=1000)

Defines for how many seconds device will keep connection to the server after successful data transfer while waiting for a new record.

Minimum value	Maximum value	Default value	Goes with (depends on) parameters	Value type
30	259200	30	Sorting (ID=1002) Server Response Timeout (ID=1001)	Uint32

9.2.3 Server Response Timeout (ID=1001)

Defines time period (in seconds) for server response to sent records.

Minimum value	Maximum value	Default value	Goes with (depends on) parameters	Value type

5	300	30	Sorting (ID=1002) Open Link Timeout (ID=1000)	Uint16
---	-----	----	--	--------



ATTENTION! Some GSM operators may disconnect the device from an active data link if the device doesn't send any data for a very long time, even if active data link timeout is set to maximum value. The amount of time that an operator keeps the link open depends solely on the operator. For example, if active data link timeout is set to maximum, 259200 seconds (72 hours), and the device sends data to server every 86400 seconds (24 hours), the operator might disconnect the link earlier and the device will have to connect to the server anew. This may cost extra, depending on the operator GPRS data charge. It is strongly recommended, when using active data link timeout, that data sending to the server should not be very rare (24 hours or more). If data sending is more frequent, then the operator will not disconnect the device from the server.

9.2.4 SIM1 GPRS content activation (ID=2000)

Parameter allows or does not allow GPRS usage with SIM1. If GPRS is not allowed value is 0, if GPRS is allowed value is 1.

Minimum value	Maximum value	Default value	Goes with (depends on) parameters	Value type
0	1	1	SIM1 SIM1 APN Name (ID=2001) SIM1 SIM1 APN username (ID=2002) SIM1 SIM1 APN Password (ID=2003)	Uint8

9.2.5 SIM1 APN Name (ID=2001)

Parameter defines SIM1 GPRS Access Point Name.

Minimum value	Maximum value	Default value	Goes with (depends on) parameters	Value type
0	32 char string	Empty	SIM1 SIM1 GPRS content activation (ID=2000) SIM1 SIM1 APN username (ID=2002) SIM1 SIM1 APN Password (ID=2003)	S8[32]

9.2.6 SIM1 APN username (ID=2002)

Parameter defines SIM1 APN username. In case operator does not use username for login, value should be empty.

Minimum value	Maximum value	Default value	Goes with (depends on) parameters	Value type
0	30 char	Empty	SIM1 SIM1 GPRS content	S8[30]

	string		activation (ID=2000) SIM1 SIM1 APN Name (ID=2001) SIM1 SIM1 APN Password (ID=2003)	
--	--------	--	--	--

9.2.7 SIM1 APN Password (ID=2003)

Parameter defines SIM1 APN password. In case operator does not use password for login, value should be empty.

Minimum value	Maximum value	Default value	Goes with (depends on) parameters	Value type
0	30 char string	Empty	SIM1 SIM1 GPRS content activation (ID=2000) SIM1 SIM1 APN Name (ID=2001) SIM1 SIM1 APN username (ID=2002)	S8[30]

9.2.8 SIM2 GPRS content activation (ID=2011)

Parameter allows or does not allow GPRS usage with SIM2. If GPRS is not allowed value is 0, if GPRS is allowed value is 1.

Minimum value	Maximum value	Default value	Goes with (depends on) parameters	Value type
0	1	1	SIM2 APN Name (ID=2012) SIM2 APN username (ID=2013) SIM2 APN Password (ID=2014)	Uint8

9.2.9 SIM2 APN Name (ID=2012)

Parameter defines SIM2 GPRS Access Point Name.

Minimum value	Maximum value	Default value	Goes with (depends on) parameters	Value type
0	32 char string	Empty	SIM2 GPRS content activation (ID=2011) SIM2 APN username (ID=2013) SIM2 APN Password (ID=2014)	S8[32]

9.2.10 SIM2 APN username (ID=2013)

Parameter defines SIM2 APN username. In case operator does not use username for login, value should be empty.

Minimum value	Maximum value	Default value	Goes with (depends on) parameters	Value type
0	30 char string	Empty	SIM2 GPRS content activation (ID=2011) SIM2 APN Name (ID=2012) SIM2 APN Password (ID=2014)	S8[30]

9.2.11 SIM2 APN Password (ID=2014)

Parameter defines SIM2 APN password. In case operator does not use password for login, value should be empty.

Minimum value	Maximum value	Default value	Goes with (depends on) parameters	Value type
0	30 char string	Empty	SIM2 GPRS content activation (ID=2011) SIM2 APN Name (ID=2012) SIM2 APN username (ID=2013)	S8[30]

9.2.12 Domain (ID=2004)

Parameter defines AVL data destination server IP address. Example: 212.47.99.62

Minimum value	Maximum value	Default value	Goes with (depends on) parameters	Value type
0	55 char string	Empty	SIM1 GPRS content activation (ID=2000)	S8[55]

9.2.13 Target Server Port (ID=2005)

Parameter defines AVL data destination server port number. Example: 12050

Minimum value	Maximum value	Default value	Goes with (depends on) parameters	Value type
0	65535	0	SIM1 GPRS content activation (ID=2000)	Uint16

9.2.14 Protocol (ID=2006)

Parameter defines GPRS data transport protocol. Module can use TCP or UDP transport protocol to send data to server. For TCP protocol value is 0, for UDP protocol value is 1.

Minimum value	Maximum value	Default value	Goes with (depends on) parameters	Value type
0	1	0	SIM1 GPRS content activation (ID=2000)	Uint8

9.2.15 Backup Server Domain (ID=2007)

Parameter defines AVL data destination backup server IP address. Example: 212.47.99.61

Minimum value	Maximum value	Default value	Goes with (depends on) parameters	Value type
0	55 char string	Empty	SIM1 GPRS content activation (ID=2000) Backup Server Mode (ID=2010)	S8[55]

9.2.16 Backup Server Port (ID=2008)

Parameter defines AVL data destination backup server port number. Example: 12051

Minimum value	Maximum value	Default value	Goes with (depends on) parameters	Value type
0	65535	0	SIM1 GPRS content activation (ID=2000) Backup Server Mode (ID=2010)	Uint16

9.2.17 Backup Server Protocol (ID=2009)

Parameter defines GPRS data transport protocol. Module can use TCP or UDP transport protocol to send data to backup server. For TCP protocol value is 0, for UDP protocol value is 1.

Minimum value	Maximum value	Default value	Goes with (depends on) parameters	Value type
0	1	0	SIM1 GPRS content activation (ID=2000) Backup Server Mode (ID=2010)	Uint8

9.2.18 Backup Server Mode (ID=2010)

Sets backup server mode: 0 – Disable (backup server not used), 1 – Backup (sent to backup server if main server not available), 2 – Duplicate (send records to both servers).

Minimum value	Maximum value	Default value	Goes with (depends on) parameters	Value type
0	2	0	SIM1 GPRS content activation (ID=2000)	Uint8

9.2.19 FOTA WEB status (ID=13003)

Parameter allows or does not allow connection to FOTA WEB server.

Minimum value	Maximum value	Default value	Goes with (depends on) parameters	Value type
0	1	1	FOTA WEB Domain (ID=13000) FOTA WEB port (ID=13001) FOTA WEB Period (min) (ID=13002)	Uint8

9.2.20 FOTA WEB Domain (ID=13000)

FOTA WEB server IP or DNS address.

Minimum value	Maximum value	Default value	Goes with (depends on) parameters	Value type
0	55 char string	85.206.140.106	FOTA WEB status (ID=13003) FOTA WEB port (ID=13001) FOTA WEB Period (min) (ID=13002)	S8[55]

9.2.21 FOTA WEB port (ID=13001)

FOTA WEB server port.

Minimum value	Maximum value	Default value	Goes with (depends on) parameters	Value type
0	65535	5000	FOTA WEB status (ID=13003) FOTA WEB Domain (ID=13000) FOTA WEB Period (min) (ID=13002)	Uint16

9.2.22 FOTA WEB Period (min) (ID=13002)

Period defines how often device is going to connect to server.

Minimum value	Maximum value	Default value	Goes with (depends on) parameters	Value type
30	65535	720	FOTA WEB status (ID=13003) FOTA WEB Domain (ID=13000) FOTA WEB port (ID=13001)	Uint16

9.3 SMS/Call settings

9.3.1 SMS data sending settings (ID=3000)

Parameter allows or does not allow sending AVL data using binary SMS. If SMS use is not allowed value is 0 and 1 if SMS use is allowed.

Minimum value	Maximum value	Default value	Goes with (depends on) parameters	Value type
0	1	0	Data send number (ID=3001)	Uint8

9.3.2 Data send number (ID=3001)

In this field are written GSM numbers, to which will be sent Data SMS.

Minimum value	Maximum value	Default value	Goes with (depends on) parameters	Value type
Empty	16 digits	-	SMS data sending settings (ID=3000)	S8[16]

9.3.3 Authorized phone numbers (ID=4000-4199)

If at least one number is entered then only those number can send messages to device.

Example: +37060012346

Minimum value	Maximum value	Default value	Goes with (depends on) parameters	Value type
Empty	16 digits	-	SMS Login (ID=3003) SMS Password (ID=3004) Digital Output control (ID=12000)	S8[16]

9.3.4 GSM Predefined Numbers (ID=6000-6009)

In this field GSM numbers are written, to which will be sent "Event SMS" text message.

Example: +37060012346

Minimum value	Maximum value	Default value	Goes with (depends on) parameters	Value type
Empty	16 digits	-	GSM number index (ID=3008) Green driving Send SMS to (ID=7034) Over Speeding Send SMS To (ID=7032) Trip Send SMS To (ID=7031) AutoGeofence Send SMS to (ID=7030) Send sms to #1-5 Geozone (ID=7025-7029), #6-50 Geozone (ID=7071-7115) Unplug send sms to (ID=7067) Towing Make Call(Sms Event Number ID) (ID=11604) Towing Send SMS (ID=7066) Crash sms send to (ID=7068) Excessive idling Send SMS To (ID=7033) I/O#1 send SMS (ID=7000) OBD II (Bluetooth) property parameters Send SMS to (ID=7038-7068)	S8[16]

9.3.5 SMS Login (ID=3003)

User login is used to ensure module security. Used in every SMS that is sent to device.
Example: ba321

Minimum value	Maximum value	Default value	Goes with (depends on) parameters	Value type
Empty	5 char	-	SMS Password (ID=3004) SMS Event Time Zone (ID=3006)	S8[5]

9.3.6 SMS Password (ID=3004)

User password is used to ensure module security. Used in every SMS that is sent to device.
Example: ab123

Minimum value	Maximum value	Default value	Goes with (depends on) parameters	Value type
Empty	5 char	-	SMS Login (ID=3003) SMS Event Time Zone (ID=3006)	S8[5]

9.3.7 Incoming call action (ID=3005)

Parameter defines action during call: 0 – do nothing, 1 – hang up, 2 – report position, 3 – Not used, 4 –Auto Answer (HF).

Minimum	Maximum	Default value	Goes with (depends on)	Value
---------	---------	---------------	------------------------	-------

value	value	parameters	type
0	4	0	Uint8

9.3.8 SMS Event Time Zone (ID=3006)

Time zone which will be used in eventual SMS messages.

Minimum value	Maximum value	Default value	Goes with (depends on) parameters	Value type
UTC-12:00	UTC+13:00	UTC+00:00	SMS Password (ID=3004) SMS Login (ID=3003)	Uint16

9.3.9 Hands Free Call Settings (ID=3007)

Parameter defines hands free call trigger:

FMB125: 0 – Disable, 1 – DIN1, 2 – Crash event, 3 – DIN1 and Crash event.

FMB120 and FMB122: 0 – Disable, 1 – DIN1, 2 – Crash event, 3 – DIN1 and Crash event 4 – DIN2, 5 - DIN1 and DIN2, 6 – Crash event and DIN2, 7 – DIN1, Crash event and DIN2.

Minimum value	Maximum value	Default value	Goes with (depends on) parameters	Value type
0	7 (3 with FMB125)	0	GSM number index (ID=3008)	Uint16

9.3.10 GSM number index (ID=3008)

Define to what number will be called after configured call trigger is activated. 0 – Disable, 1-10 – call to configured GSM Predefined Number.

Minimum value	Maximum value	Default value	Goes with (depends on) parameters	Value type
0	10	0	Hands Free Call Settings (ID=3007) GSM Predefined Numbers (ID=6000-6009)	Uint8

9.4 GSM Operators

9.4.1 SIM1 Roaming Operator List (ID=5000-5049)

Parameter defines roaming operator list for SIM 1. According to this list module selects operating profile. If roaming operator list is left empty, FMB1YX will automatically detect home operator. If home operator will be written to roaming operator list any part, it will be detected as home operator, not roaming. All other written operators are Preferred Roaming Operator Codes. More information about operator search functionality in [5.7 chapter \(GSM Operators, SIM1 Roaming and SIM2 Roaming/ Home Operator list, Blacklist Operator list\)](#).

Minimum value	Maximum value	Default value	Goes with (depends on) parameters	Value type
0	999999	0	Black List (ID=5500-5549)	Uint32

9.4.2 SIM2 Roaming/ Home Operator List (ID=9500-9549)

Parameter defines roaming/ home operator list for SIM2. More information about operator search functionality in [5.7 chapter \(GSM Operators, SIM1 Roaming and SIM2 Roaming/ Home Operator list, Blacklist Operator list\)](#).

Minimum value	Maximum value	Default value	Goes with (depends on) parameters	Value type
0	999999	0	Black List (ID=5500-5549)	Uint32

9.4.3 Black List (ID=5500-5549)

Operator Blacklist - if user wants that FMB1YX do not connect and work with a particular operator it must be written to Operator BlackList. All functionality described in [5.7 chapter \(GSM Operators, SIM1 Roaming and SIM2 Roaming/ Home Operator list, Blacklist Operator list\)](#).

Minimum value	Maximum value	Default value	Goes with (depends on) parameters	Value type
0	999999	0	Roaming Operator List (ID=5000-5049)	Uint32

9.5 Data Acquisition Modes parameters

9.5.1 Home Network GSM operator code "Vehicle on STOP" parameters

9.5.1.1 Min Period (ID=10000)

This parameter indicates time interval in seconds in order to acquire new record. If value is 0 it means no records by min period will be saved.

Minimum value	Maximum value	Default value	Goes with (depends on) parameters	Value type
0	2592000	3600	Min Saved Records (ID=10004) Send Period (ID=10005)	Uint32

9.5.1.2 Min Saved Records (ID=10004)

This parameter defines minimum number of records in one data packet that can be sent to server. It has higher priority than Data Send Period (ID=10005).

Minimum value	Maximum value	Default value	Goes with (depends on) parameters	Value type
1	255	1	Min Period (ID=10000) Send Period (ID=10005)	Uint8

9.5.1.3 Send Period (ID=10005)

This parameter indicates frequency (time interval in seconds) of sending data to server.

Minimum value	Maximum value	Default value	Goes with (depends on) parameters	Value type
0	2592000	120	Min Period (ID=10000)	Uint32

			Min Saved Records (ID=10004)	
--	--	--	---------------------------------	--

9.5.2 Home Network GSM operator code “Vehicle MOVING” parameters

9.5.2.1 Min Period (ID=10050)

This parameter indicates time interval in seconds in order to acquire new record. If value is 0 it means no records by min period will be saved.

Minimum value	Maximum value	Default value	Goes with (depends on) parameters	Value type
0	2592000	300	Min Distance (ID=10051) Min Angle (ID=10052) Min Speed Delta (ID=10053) Min Saved Records (ID=10054) Send Period (ID=10055)	Uint32

9.5.2.2 Min Distance (ID=10051)

This parameter indicates distance in meters in order to acquire new record. Record is stored when the distance between previous records is greater than parameters value. If value is 0 it means no records by min distance will be saved.

Minimum value	Maximum value	Default value	Goes with (depends on) parameters	Value type
0	65535	100	Min Period (ID=10050) Min Angle (ID=10052) Min Speed Delta (ID=10053) Min Saved Records (ID=10054) Send Period (ID=10055)	Uint16

9.5.2.3 Min Angle (ID=10052)

This parameter indicates angle in degrees in order to acquire new record. If angle difference between last recorded coordinate and current position is greater than defined value, new record is stored. This parameter is operational, when speed is higher than 10km/h. If value is 0 it means no records by min angle will be saved.

Minimum value	Maximum value	Default value	Goes with (depends on) parameters	Value type
0	180	10	Min Period (ID=10050) Min Distance (ID=10051) Min Speed Delta (ID=10053) Min Saved Records (ID=10054) Send Period (ID=10055)	Uint8

9.5.2.4 Min Speed Delta (ID=10053)

This parameter indicates speed difference in order to acquire new record. If speed difference between last recorded coordinate and current position is greater than defined value, new record is stored. If value is 0 it means no records by min speed delta will be saved.

Minimum value	Maximum value	Default value	Goes with (depends on) parameters	Value type
0	255	10	Min Period (ID=10050) Min Distance (ID=10051) Min Angle (ID=10052) Min Saved Records (ID=10054) Send Period (ID=10055)	Uint8

9.5.2.5 Min Saved Records (ID=10054)

This parameter defines minimum number of records in one data packet that can be sent to server. It has higher priority than Data Send Period (ID=10055).

Minimum value	Maximum value	Default value	Goes with (depends on) parameters	Value type
1	255	1	Min Period (ID=10050) Min Distance (ID=10051) Min Angle (ID=10052) Min Speed Delta (ID=10053) Send Period (ID=10055)	Uint8

9.5.2.6 Send Period (ID=10055)

This parameter indicates frequency (time interval in seconds) of sending data to server.

Minimum value	Maximum value	Default value	Goes with (depends on) parameters	Value type
0	2592000	120	Min Period (ID=10050) Min Distance (ID=10051) Min Angle (ID=10052) Min Speed Delta (ID=10053) Min Saved Records (ID=10054)	Uint32

9.5.3 Roaming Network GSM operator code "Vehicle on STOP" parameters

9.5.3.1 Min Period (ID=10100)

This parameter indicates time interval in seconds in order to acquire new record. If value is 0 it means no records by min period will be saved.

Minimum value	Maximum value	Default value	Goes with (depends on) parameters	Value type
0	2592000	3600	Min Saved Records (ID=10104)	Uint32

			Send Period (ID=10105)	
--	--	--	------------------------	--

9.5.3.2 Min Saved Records (ID=10104)

This parameter defines minimum number of records in one data packet that can be sent to server. It has higher priority than Data Send Period (ID=10105).

Minimum value	Maximum value	Default value	Goes with (depends on) parameters	Value type
1	255	1	Min Period (ID=10100) Send Period (ID=10105)	Uint8

9.5.3.3 Send Period (ID=10105)

This parameter indicates frequency (time interval in seconds) of sending data to server.

Minimum value	Maximum value	Default value	Goes with (depends on) parameters	Value type
0	2592000	120	Min Period (ID=10100) Min Saved Records (ID=10104)	Uint32

9.5.4 Roaming Network GSM operator code "Vehicle MOVING" parameters

9.5.4.1 Min Period (ID=10150)

This parameter indicates time interval in seconds in order to acquire new record. If value is 0 it means no records by min period will be saved.

Minimum value	Maximum value	Default value	Goes with (depends on) parameters	Value type
0	2592000	300	Min Distance (ID=10151) Min Angle (ID=10152) Min Speed Delta (ID=10153) Min Saved Records (ID=10154) Send Period (ID=10155)	Uint32

9.5.4.2 Min Distance (ID=10151)

This parameter indicates distance in meters in order to acquire new record. Record is stored when the distance between previous records is greater than parameter's value. If value is 0 it means no records by min distance will be saved.

Minimum value	Maximum value	Default value	Goes with (depends on) parameters	Value type
0	65535	100	Min Period (ID=10150) Min Angle (ID=10152) Min Speed Delta (ID=10153) Min Saved Records (ID=10154) Send Period (ID=10155)	Uint16

9.5.4.3 Min Angle (ID=10152)

This parameter indicates angle in degrees in order to acquire new record. If angle difference between last recorded coordinate and current position is greater than defined value, new record is stored. This parameter is operational, when speed is higher than 10km/h. If value is 0 it means no records by min angle will be saved.

Minimum value	Maximum value	Default value	Goes with (depends on) parameters	Value type
0	180	10	Min Period (ID=10150) Min Distance (ID=10151) Min Speed Delta (ID=10153) Min Saved Records (ID=10154) Send Period (ID=10155)	Uint8

9.5.4.4 Min Speed Delta (ID=10153)

This parameter indicates speed difference in order to acquire new record. If speed difference between last recorded coordinate and current position is greater than defined value, new record is stored. If value is 0 it means no records by min speed delta will be saved.

Minimum value	Maximum value	Default value	Goes with (depends on) parameters	Value type
0	255	10	Min Period (ID=10150) Min Distance (ID=10151) Min Angle (ID=10152) Min Saved Records (ID=10154) Send Period (ID=10155)	Uint8

9.5.4.5 Min Saved Records (ID=10154)

This parameter defines minimum number of records in one data packet that can be sent to server. It has higher priority than Data Send Period (ID=10105).

Minimum value	Maximum value	Default value	Goes with (depends on) parameters	Value type
1	255	1	Min Period (ID=10150) Min Distance (ID=10151) Min Angle (ID=10152) Min Speed Delta (ID=10153) Send Period (ID=10155)	Uint8

9.5.4.6 Send Period (ID=10155)

This parameter indicates frequency (time interval in seconds) of sending data to server.

Minimum value	Maximum value	Default value	Goes with (depends on) parameters	Value type
0	2592000	120	Min Period (ID=10150)	Uint32

			Min Distance (ID=10151) Min Angle (ID=10152) Min Speed Delta (ID=10153) Min Saved Records (ID=10154)	
--	--	--	---	--

9.5.5 Unknown Network GSM operator code “Vehicle on STOP” parameters

9.5.5.1 Min Period (ID=10200)

This parameter indicates time interval in seconds in order to acquire new record. If value is 0 it means no records by min period will be saved.

Minimum value	Maximum value	Default value	Goes with (depends on) parameters	Value type
0	2592000	3600	Min Saved Records (ID=10204) Send Period (ID=10205)	Uint32

9.5.5.2 Min Saved Records (ID=10204)

This parameter defines minimum number of records in one data packet that can be sent to server. It has higher priority than Data Send Period (ID=10205).

Minimum value	Maximum value	Default value	Goes with (depends on) parameters	Value type
1	255	1	Min Period (ID=10200) Send Period (ID=10205)	Uint8

9.5.5.3 Send Period (ID=10205)

This parameter indicates frequency (time interval in seconds) of sending data to server.

Minimum value	Maximum value	Default value	Goes with (depends on) parameters	Value type
0	2592000	120	Min Period (ID=10200) Min Saved Records (ID=10204)	Uint32

9.5.6 Unknown Network GSM operator code “Vehicle MOVING” parameters

9.5.6.1 Min Period (ID=10250)

This parameter indicates time interval in seconds in order to acquire new record. If value is 0 it means no records by min period will be saved.

Minimum value	Maximum value	Default value	Goes with (depends on) parameters	Value type
0	2592000	300	Min Distance (ID=10251) Min Angle (ID=10252) Min Speed (ID=10253) Min Saved Records	Uint32

			(ID=10254) Send Period (ID=10255)	
--	--	--	--------------------------------------	--

9.5.6.2 Min Distance (ID=10251)

This parameter indicates distance in meters in order to acquire new record. Record is stored when the distance between previous records is greater than parameter's value. If value is 0 it means no records by min distance will be saved.

Minimum value	Maximum value	Default value	Goes with (depends on) parameters	Value type
0	65535	100	Min Period (ID=10250) Min Angle (ID=10252) Min Speed (ID=10253) Min Saved Records (ID=10254) Send Period (ID=10255)	Uint16

9.5.6.3 Min Angle (ID=10252)

This parameter indicates angle in degrees in order to acquire new record. If angle difference between last recorded coordinate and current position is greater than defined value, new record is stored. This parameter is operational, when speed is higher than 10km/h. If value is 0 it means no records by min angle will be saved.

Minimum value	Maximum value	Default value	Goes with (depends on) parameters	Value type
0	180	10	Min Period (ID=10250) Min Distance (ID=10251) Min Speed (ID=10253) Min Saved Records (ID=10254) Send Period (ID=10255)	Uint8

9.5.6.4 Min Speed (ID=10253)

This parameter indicates speed difference in order to acquire new record. If speed difference between last recorded coordinate and current position is greater than defined value, new record is stored. If value is 0 it means no records by min speed delta will be saved.

Minimum value	Maximum value	Default value	Goes with (depends on) parameters	Value type
0	255	10	Min Period (ID=10250) Min Distance (ID=10251) Min Angle (ID=10252) Min Saved Records (ID=10254) Send Period (ID=10255)	Uint8

9.5.6.5 Min Saved Records (ID=10254)

This parameter defines minimum number of records in one data packet that can be sent to server. It has higher priority than Data Send Period (ID=10105).

Minimum	Maximum	Default value	Goes with (depends on)	Value
---------	---------	---------------	------------------------	-------

value	value		parameters	type
1	255	1	Min Period (ID=10250) Min Distance (ID=10251) Min Angle (ID=10252) Min Speed (ID=10253) Send Period (ID=10255)	Uint8

9.5.6.6 Send Period (ID=10255)

This parameter indicates frequency (time interval in seconds) of sending data to server.

Minimum value	Maximum value	Default value	Goes with (depends on) parameters	Value type
0	2592000	120	Min Period (ID=10250) Min Distance (ID=10251) Min Angle (ID=10252) Min Speed (ID=10253) Min Saved Records (ID=10254)	Uint32

9.6 Features Parameters

9.6.1 Green driving parameters

9.6.1.1 Green driving priority (ID=11000)

Defines priority of green driving scenario: 0 – disabled, 1 – low, 2 – high, 3 – panic.

Minimum value	Maximum value	Default value	Goes with (depends on) parameters	Value type
0	3	0	Max Acceleration Force (ID=11004) Max Braking Force (ID=11005) Max Cornering (ID=11006) Green/Eco driving (ID=11007) Green driving digital output control settings (ID=11003) Green driving Digital output on duration (ID=11001) Green driving Digital output off duration (ID=11002) Green driving Send SMS to (ID=7034) Green driving SMS text (ID=8034)	Uint8

9.6.1.2 Max Acceleration Force (ID=11004)

It is max allowed acceleration force which can be reached while accelerating without triggering harsh acceleration event (m/s²).

Minimum value	Maximum value	Default value	Goes with (depends on) parameters	Value type
0.5	10	2.2	Green driving priority (ID=11000) Max Braking Force (ID=11005) Max Cornering (ID=11006) Green/Eco driving (ID=11007) Green driving digital output control settings (ID=11003) Green driving Digital output on duration (ID=11001) Green driving Digital output off duration (ID=11002) Green driving Send SMS to (ID=7034) Green driving SMS text (ID=8034)	float

9.6.1.3 Max Braking Force (ID=11005)

It is max allowed braking force which can be reached while braking without triggering harsh braking event (m/s^2).

Minimum value	Maximum value	Default value	Goes with (depends on) parameters	Value type
0.5	10	2.5	Green driving priority (ID=11000) Max Acceleration Force (ID=11004) Max Cornering (ID=11006) Green/Eco driving (ID=11007) Green driving digital output control settings (ID=11003) Green driving Digital output on duration (ID=11001) Green driving Digital output off duration (ID=11002) Green driving Send SMS to (ID=7034) Green driving SMS text (ID=8034)	float

9.6.1.4 Max Cornering (ID=11006)

It is max allowed cornering angle which can be reached while cornering without triggering harsh cornering event (m/s^2).

Minimum value	Maximum value	Default value	Goes with (depends on) parameters	Value type
---------------	---------------	---------------	-----------------------------------	------------

0.5	10	2.1	Green driving priority (ID=11000) Max Acceleration Force (ID=11004) Max Braking Force (ID=11005) Green/Eco driving (ID=11007) Green driving digital output control settings (ID=11003) Green driving Digital output on duration (ID=11001) Green driving Digital output off duration (ID=11002) Green driving Send SMS to (ID=7034) Green driving SMS text (ID=8034)	float
-----	----	-----	--	-------

9.6.1.5 Green/Eco driving (ID=11007)

Choose between Eco driving(accelerometer) and Green driving(gps). 0 – GPS, 1 – Accelerometer

Minimum value	Maximum value	Default value	Goes with (depends on) parameters	Value type
0	1	0	Green driving priority (ID=11000) Max Acceleration Force (ID=11004) Max Braking Force (ID=11005) Max Cornering (ID=11006) Green driving digital output control settings (ID=11003) Green driving Digital output on duration (ID=11001) Green driving Digital output off duration (ID=11002) Green driving Send SMS to (ID=7034) Green driving SMS text (ID=8034)	Uint8

9.6.1.6 Green driving digital output control settings (ID=11003)

Enables DOUT1 (1), enables DOUT2 (2)¹ or disables (0) Green driving output control.

Minimum value	Maximum value	Default value	Goes with (depends on) parameters	Value type
0	2 (1 ¹)	0	Green driving priority	Uint8

¹ Only with FMB120 and FMB122 devices.

			(ID=11000) Max Acceleration Force (ID=11004) Max Braking Force (ID=11005) Max Cornering (ID=11006) Green/Eco driving (ID=11007) Green driving Digital output on duration (ID=11001) Green driving Digital output off duration (ID=11002) Green driving Send SMS to (ID=7034) Green driving SMS text (ID=8034)	
--	--	--	--	--

9.6.1.7 Green driving Digital output on duration (ID=11001)
 Output ON duration in mili-seconds

Minimum value	Maximum value	Default value	Goes with (depends on) parameters	Value type
100	5000	200	Green driving priority (ID=11000) Max Acceleration Force (ID=11004) Max Braking Force (ID=11005) Max Cornering (ID=11006) Green/Eco driving (ID=11007) Green driving digital output control settings (ID=11003) Green driving Digital output off duration (ID=11002) Green driving Send SMS to (ID=7034) Green driving SMS text (ID=8034)	Uint32

9.6.1.8 Green driving Digital output off duration (ID=11002)
 Output OFF duration in in mili-seconds

Minimum value	Maximum value	Default value	Goes with (depends on) parameters	Value type
0	5000	200	Green driving priority (ID=11000) Max Acceleration Force (ID=11004)	Uint32

¹ Max value with FMB125 is 1.

			Max Braking Force (ID=11005) Max Cornering (ID=11006) Green/Eco driving (ID=11007) Green driving digital output control settings (ID=11003) Green driving Digital output on duration (ID=11001) Green driving Send SMS to (ID=7034) Green driving SMS text (ID=8034)	
--	--	--	--	--

9.6.1.9 Green driving Send SMS to (ID=7034)

Enable/disable sms event sending. 0 – Disable, 1-10 – sms will be sent to configured GSM number.

Minimum value	Maximum value	Default value	Goes with (depends on) parameters	Value type
0	10	0	Green driving priority (ID=11000) Max Acceleration Force (ID=11004) Max Braking Force (ID=11005) Max Cornering (ID=11006) Green/Eco driving (ID=11007) Green driving digital output control settings (ID=11003) Green driving Digital output on duration (ID=11001) Green driving Digital output off duration (ID=11002) Green driving SMS text (ID=8034) GSM Predefined Numbers (ID=6000-6009)	Uint8

9.6.1.10 Green driving SMS text (ID=8034)

Configure green driving sms event text here.

Minimum value	Maximum value	Default value	Goes with (depends on) parameters	Value type
0	160 char	Green Driving	Green driving priority (ID=11000) Max Acceleration Force (ID=11004) Max Braking Force (ID=11005)	S8[160]

			Max Cornering (ID=11006) Green/Eco driving (ID=11007) Green driving digital output control settings (ID=11003) Green driving Digital output on duration (ID=11001) Green driving Digital output off duration (ID=11002) Green driving Send SMS to (ID=7034)	
--	--	--	--	--

9.6.2 Overspeeding scenario parameters

9.6.2.1 Overspeeding priority (ID=11100)

Defines priority of overspeeding scenario: 0 – disabled, 1 – low, 2 – high, 3 – panic.

Minimum value	Maximum value	Default value	Goes with (depends on) parameters	Value type
0	3	0	Max allowed Speed (ID=11104) Overspeeding output control (ID=11103) Overspeeding Digital output on duration (ID=11101) Overspeeding Digital output off duration (ID=11102) Over Speeding Send SMS To (ID=7032) Over Speeding SMS Text (ID=8032)	Uint8

9.6.2.2 Max allowed Speed (ID=11104)

It is max allowed speed which can be reached. If this value exceeded Over speeding event will occur.

Minimum value	Maximum value	Default value	Goes with (depends on) parameters	Value type
0	260	90	Overspeeding priority (ID=11100) Overspeeding output control (ID=11103) Overspeeding Digital output on duration (ID=11101) Overspeeding Digital output off duration (ID=11102) Over Speeding Send SMS To (ID=7032)	Uint16

			Over Speeding SMS Text (ID=8032)	
--	--	--	----------------------------------	--

9.6.2.3 Overspeeding output control (ID=11103)

Enables DOUT1 (1), enables DOUT2 (2)¹ or disables (0) overspeeding output control.

Minimum value	Maximum value	Default value	Goes with (depends on) parameters	Value type
0	2 (1 ²)	0	Overspeeding priority (ID=11100) Max allowed Speed (ID=11104) Overspeeding Digital output on duration (ID=11101) Overspeeding Digital output off duration (ID=11102) Over Speeding Send SMS To (ID=7032) Over Speeding SMS Text (ID=8032)	Uint8

9.6.2.4 Overspeeding Digital output on duration (ID=11101)

Output ON duration in mili-seconds

Minimum value	Maximum value	Default value	Goes with (depends on) parameters	Value type
100	5000	200	Overspeeding priority (ID=11100) Max allowed Speed (ID=11104) Overspeeding output control (ID=11103) Overspeeding Digital output off duration (ID=11102) Over Speeding Send SMS To (ID=7032) Over Speeding SMS Text (ID=8032)	Int32

9.6.2.5 Overspeeding Digital output off duration (ID=11102)

Output OFF duration in mili-seconds

Minimum value	Maximum value	Default value	Goes with (depends on) parameters	Value type
0	5000	200	Overspeeding priority (ID=11100) Max allowed Speed (ID=11104) Overspeeding output control	Int32

¹ Only with FMB120 and FMB122 devices

² Max value with FMB125 is 1.

			(ID=11103) Overspeeding Digital output on duration (ID=11101) Over Speeding Send SMS To (ID=7032) Over Speeding SMS Text (ID=8032)	
--	--	--	---	--

9.6.2.6 Overspeeding Send SMS To (ID=7032)

Enable/disable sms event sending. 0 – Disable, 1-10 – sms will be sent to configured GSM number.

Minimum value	Maximum value	Default value	Goes with (depends on) parameters	Value type
0	10	0	Overspeeding priority (ID=11100) Max allowed Speed (ID=11104) Overspeeding output control (ID=11103) Overspeeding Digital output on duration (ID=11101) Overspeeding Digital output off duration (ID=11102) Over Speeding SMS Text (ID=8032) GSM Predefined Numbers (ID=6000-6009)	UInt8

9.6.2.7 Overspeeding SMS Text (ID=8032)

Configure over speeding sms event text here.

Minimum value	Maximum value	Default value	Goes with (depends on) parameters	Value type
0	160 char	Overspeeding	Overspeeding priority (ID=11100) Max allowed Speed (ID=11104) Overspeeding output control (ID=11103) Overspeeding Digital output on duration (ID=11101) Overspeeding Digital output off duration (ID=11102) Over Speeding Send SMS To (ID=7032)	S8[160]

9.6.3 Jamming scenario parameters

9.6.3.1 Jamming priority (ID=11300)

Scenario settings: 0 – Disable, 1 – Low, 2 – High, 3 – Panic

Minimum value	Maximum value	Default value	Goes with (depends on) parameters	Value type
0	3	0	Jamming Eventual records (ID=11303) Jamming Output Control (ID=11304) Time Until Jamming Event Detection(ID=11305) Jamming DOUT on duration [ms] (ID=11301) Jamming DOUT off duration [ms] (ID=11302)	Uint8

9.6.3.2 Jamming Eventual records (ID=11303)

Disables or enables eventual records. 0 – Disable, 1 – Enable

Minimum value	Maximum value	Default value	Goes with (depends on) parameters	Value type
0	1	1	Jamming priority (ID=11300) Jamming Output Control (ID=11304) Time Until Jamming Event Detection(ID=11305) Jamming DOUT on duration [ms] (ID=11301) Jamming DOUT off duration [ms] (ID=11302)	Uint8

9.6.3.3 Jamming Output Control (ID=11304)

Enables DOUT1 (1), enables DOUT2 (2)¹ or disables (0) Jamming output control.

Minimum value	Maximum value	Default value	Goes with (depends on) parameters	Value type
0	2 (1 ²)	0	Jamming priority (ID=11300) Jamming Eventual records (ID=11303) Time Until Jamming Event Detection(ID=11305) Jamming DOUT on duration	Uint8

¹ Only with FMB120 and FMB122 devices

² Max value with FMB125 is 1.

			[ms] (ID=11301) Jamming DOUT off duration [ms] (ID=11302)	
--	--	--	---	--

9.6.3.4 Time Until Jamming Event Detection(ID=11305)

After Jamming trigger count TMO (in seconds), control OUTPUT and generate event after this timeout. If Jamming End trigger is detected during counting no event will be generated and output will not be controlled.

Minimum value	Maximum value	Default value	Goes with (depends on) parameters	Value type
0	65535	60	Jamming priority (ID=11300) Jamming Eventual records (ID=11303) Jamming Output Control (ID=11304) Jamming DOUT on duration [ms] (ID=11301) Jamming DOUT off duration [ms] (ID=11302)	Uint16

9.6.3.5 Jamming DOUT on duration [ms] (ID=11301)

Sets time period, that Dout will be on.

Minimum value	Maximum value	Default value	Goes with (depends on) parameters	Value type
100	5000	200	Jamming priority (ID=11300) Jamming Eventual records (ID=11303) Jamming Output Control (ID=11304) Time Until Jamming Event Detection(ID=11305) Jamming DOUT off duration [ms] (ID=11302)	Int32

9.6.3.6 Jamming DOUT off duration [ms] (ID=11302)

Sets time period, that Dout will be off.

Minimum value	Maximum value	Default value	Goes with (depends on) parameters	Value type
0	5000	200	Jamming priority (ID=11300) Jamming Eventual records (ID=11303) Jamming Output Control (ID=11304) Time Until Jamming Event Detection(ID=11305)	Int32

			Jamming DOUT on duration [ms] (ID=11301)	
--	--	--	--	--

9.6.4 Immobilizer scenario parameters

9.6.4.1 Scenario settings (ID=11700)

Scenario settings: 0 – Disable, 1 – Low Priority, 2 – High Priority, 3 – Panic Priority.

Minimum value	Maximum value	Default value	Goes with (depends on) parameters	Value type
0	3	0	Eventual records (ID=11701) Output control (ID=11702) iButton list check (ID=11703) Send SMS to (ID=7140) SMS text (ID=8140)	Uint8

9.6.4.2 Eventual records (ID=11701)

Disables or enables eventual records. 0 – Disable, 1 – Enable

Minimum value	Maximum value	Default value	Goes with (depends on) parameters	Value type
0	1	1	Scenario settings (ID=11700) Output control (ID=11702) iButton list check (ID=11703) Send SMS to (ID=7140) SMS text (ID=8140)	Uint8

9.6.4.3 Output control (ID=11702)

Defines rather immobilizer will control digital output or not. 0 – Disable, 1 – Enable (DOUT1), 2 – Enable (DOUT2)¹.

Minimum value	Maximum value	Default value	Goes with (depends on) parameters	Value type
0	2 (1 ²)	0	Scenario settings (ID=11700) Eventual records (ID=11701) iButton list check (ID=11703) Send SMS to (ID=7140) SMS text (ID=8140)	Uint8

9.6.4.4 iButton list check (ID=11703)

iButton list check – option to select if it is necessary to check configured iButton list (1 – Authorized Driving behavior) or not (0 – Immobilizer behavior).

Minimum	Maximum	Default value	Goes with (depends on)	Value
---------	---------	---------------	------------------------	-------

¹ Only with FMB120 and FMB122 devices

² Max value with FMB125 is 1.

value	value		parameters	type
0	1	0	Scenario settings (ID=11700) Eventual records (ID=11701) Output control (ID=11702) Send SMS to (ID=7140) SMS text (ID=8140) iButton List (ID=30000 – 30500)	Uint8

9.6.4.5 Send SMS to (ID=7140)

Enable/disable sms event sending. 0 – Disable, 1-10 – sms will be sent to configured GSM number.

Minimum value	Maximum value	Default value	Goes with (depends on) parameters	Value type
0	10	0	Scenario settings (ID=11700) Eventual records (ID=11701) Output control (ID=11702) iButton list check (ID=11703) SMS text (ID=8140)	Uint8

9.6.4.6 SMS text (ID=8140)

Configure Immobilizer sms event text here.

Minimum value	Maximum value	Default value	Goes with (depends on) parameters	Value type
0	160	Immobilizer	Scenario settings (ID=11700) Eventual records (ID=11701) Output control (ID=11702) iButton list check (ID=11703) Send SMS to (ID=7140)	String

9.6.5 Trip scenario parameters

9.6.5.1 Trip priority (ID=11800)

Defines priority of trip scenario:

0 – disabled, 1 – low, 2 – high, 3 – panic

Minimum value	Maximum value	Default value	Goes with (depends on) parameters	Value type
0	3	0	Eventually Records (ID=11801) Trip mode (ID=11802) Start Speed (ID=11803) Ignition Off Timeout (ID=11804) Eco Score allowed events (ID=700) Trip Send SMS To (ID=7031) Trip SMS Text (ID=8031)	Uint8

			Odometer distance calculation source (ID=11806)	
--	--	--	---	--

9.6.5.2 Eventually Records (ID=11801)

Disables or enables eventual records. 0 – Disable, 1 – Enable.

Minimum value	Maximum value	Default value	Goes with (depends on) parameters	Value type
0	1	0	Trip priority (ID=11800) Trip mode (ID=11802) Start Speed (ID=11803) Ignition Off Timeout (ID=11804) Eco Score allowed events (ID=700) Trip Send SMS To (ID=7031) Trip SMS Text (ID=8031) Odometer distance calculation source (ID=11806)	Uint8

9.6.5.3 Trip mode (ID=11802)

For this feature I/O ODOMETER must be enabled. If I/O ODOMETER is enabled, and mode is set to Continuous (value 0), TRIP distance is going to be counted till the end of trip, if between records mode is set, ODOMETER will count distance only between two records.

Minimum value	Maximum value	Default value	Goes with (depends on) parameters	Value type
0	1	0	Trip priority (ID=11800) Eventually Records (ID=11801) Start Speed (ID=11803) Ignition Off Timeout (ID=11804) Eco Score allowed events (ID=700) Trip Send SMS To (ID=7031) Trip SMS Text (ID=8031) Odometer distance calculation source (ID=11806)	Uint8

9.6.5.4 Start Speed (ID=11803)

This parameter represents speed (km/h), which is detected as minimum speed to indicate TRIP START and generate event.

Minimum value	Maximum value	Default value	Goes with (depends on) parameters	Value type
0	255	5	Trip priority (ID=11800) Eventually Records (ID=11801) Trip mode (ID=11802) Ignition Off Timeout (ID=11804)	Uint8

			Eco Score allowed events (ID=700) Trip Send SMS To (ID=7031) Trip SMS Text (ID=8031) Odometer distance calculation source (ID=11806)	
--	--	--	---	--

9.6.5.5 Ignition Off Timeout (ID=11804)

This parameter represents timeout to wait if ignition (ignition source) is off in order to detect TRIP STOP and generate event.

Minimum value	Maximum value	Default value	Goes with (depends on) parameters	Value type
0	65535	60	Trip priority (ID=11800) Eventually Records (ID=11801) Trip mode (ID=11802) Start Speed (ID=11803) Eco Score allowed events (ID=700) Trip Send SMS To (ID=7031) Trip SMS Text (ID=8031) Odometer distance calculation source (ID=11806)	Uint16

9.6.5.6 Eco Score allowed events (ID=700)

How much Eco score events are allowed to generate in 100 km trip distance, that ECO score result would be excellent (10).

Minimum value	Maximum value	Default value	Goes with (depends on) parameters	Value type
0	65535	10	Trip priority (ID=11800) Eventually Records (ID=11801) Trip mode (ID=11802) Start Speed (ID=11803) Ignition Off Timeout (ID=11804) Trip Send SMS To (ID=7031) Trip SMS Text (ID=8031) Odometer distance calculation source (ID=11806)	Uint16

9.6.5.7 Trip Send SMS To (ID=7031)

Enable/disable sms event sending. 0 – Disable, 1-10 – sms will be sent to configured GSM number.

Minimum value	Maximum value	Default value	Goes with (depends on) parameters	Value type
0	10	0	Trip priority (ID=11800) Eventually Records (ID=11801)	UInt8

			Trip mode (ID=11802) Start Speed (ID=11803) Ignition Off Timeout (ID=11804) Eco Score allowed events (ID=700) Trip SMS Text (ID=8031) Odometer distance calculation source (ID=11806) GSM Predefined Numbers (ID=6000-6009)	
--	--	--	---	--

9.6.5.8 Trip SMS Text (ID=8031)

Configure trip sms event text here.

Minimum value	Maximum value	Default value	Goes with (depends on) parameters	Value type
0	160	Trip	Trip priority (ID=11800) Eventually Records (ID=11801) Trip mode (ID=11802) Start Speed (ID=11803) Ignition Off Timeout (ID=11804) Eco Score allowed events (ID=700) Trip Send SMS To (ID=7031) Odometer distance calculation source (ID=11806)	S8[160]

9.6.5.9 Odometer distance calculation source (ID=11806)

Sets odometer distance calculation source: 0 – GNSS, 1 – OBD (Bluetooth dongle), 2 – LVCAN

Minimum value	Maximum value	Default value	Goes with (depends on) parameters	Value type
0	2	0	Trip priority (ID=11800) Eventually Records (ID=11801) Trip mode (ID=11802) Start Speed (ID=11803) Ignition Off Timeout (ID=11804) Eco Score allowed events (ID=700) Trip Send SMS To (ID=7031) Trip SMS Text (ID=8031)	Uint8

9.6.5.10 Total Odometer value (ID=11807)

Sets total odometer value (km).

Minimum value	Maximum value	Default value	Goes with (depends on) parameters	Value type
0	9999999	0	I/O Total Odometer (ID=50160-50164)	Uint32

9.6.5.11 Remember iButton ID (ID=11805)

This parameter enables/disables Remember iButton ID functionality. 0 – disable, 1 – enable.

Minimum value	Maximum value	Default value	Goes with (depends on) parameters	Value type
0	1	0	Trip priority (ID=11800) Eventually Records (ID=11801) Trip mode (ID=11802) Start Speed (ID=11803) Ignition Off Timeout (ID=11804) Eco Score allowed events (ID=700) Trip Send SMS To (ID=7031) Trip SMS Text (ID=8031) iButton List (ID=30000 – 30500)	Uint8

9.6.6 DOUT control via call scenario parameters

9.6.6.1 Digital Output control (ID=12000)

Disable or enable scenario. If enabled DOUT1 (1) or DOUT2 (2)¹ will be controlled via authorized numbers calls.

Minimum value	Maximum value	Default value	Goes with (depends on) parameters	Value type
0	2 (1 ²)	0	DOUT deactivation (ID=12001) Duration timeout (ID=12002) Authorized phone numbers (ID=4000-4199)	Uint8

9.6.6.2 DOUT deactivation (ID=12001)

Disable or enable DOUT deactivation by Digital Input. If enabled Digital input will deactivate Digital output. 0 – disabled, 1 – DIN1, 2 – DIN³, 3 – DIN³⁴.

¹ Only with FMB120 and FMB122 devices

² Max value with FMB125 is 1.

³ Only with FMB120 and FMB122 devices

⁴ Only with FMB120 and FMB122 devices

Minimum value	Maximum value	Default value	Goes with (depends on) parameters	Value type
0	3 (1 ¹)	0	Digital Output control (ID=12000) Duration timeout (ID=12002)	Uint8

9.6.6.3 Duration timeout (ID=12002)

DOUT on duration timeout.

Minimum value	Maximum value	Default value	Goes with (depends on) parameters	Value type
0	2147483647	5	Digital Output control (ID=12000) DOUT deactivation (ID=12001)	Int32

9.6.7 iButton read notification

9.6.7.1 Digital Output control (ID=11704)

Disable or enable scenario. If enabled DOUT1 (1) or DOUT2 (2)² will be turned on when iButton are attached.

Minimum value	Maximum value	Default value	Goes with (depends on) parameters	Value type
0	2 (1 ¹)	0	Duration timeout [ms] (ID=11705)	Uint8

9.6.7.2 Duration timeout [ms] (ID=11705)

DOUT on duration timeout.

Minimum value	Maximum value	Default value	Goes with (depends on) parameters	Value type
100	5000	200	Digital Output control (ID=11704)	Uint8

9.7 AutoGeofencing scenario parameters

9.7.1 AutoGeofencing priority (ID=20000)

Defines priority of autogeofencing scenario:

0 – disabled, 1 – low, 2 – high, 3 – panic

Minimum value	Maximum value	Default value	Goes with (depends on) parameters	Value type
0	3	0	Eventual Records (ID=20002) Activation Timeout (ID=20003) Deactivate by (ID=20005)	Uint8

¹ Max value with FMB125 is 1.

² Only with FMB120 and FMB122 devices

			AutoGeofence event generating (ID=20001) Radius (ID=20004) Send sms to (ID=7030) SMS Text (ID=8030)	
--	--	--	--	--

9.7.2 Eventual Records (ID=20002)

0 – disable, include parameter to all records, 1 – enable, include parameter to record only if event was generated.

Minimum value	Maximum value	Default value	Goes with (depends on) parameters	Value type
0	1	1	AutoGeofencing priority (ID=20000) Activation Timeout (ID=20003) Deactivate by (ID=20005) AutoGeofence event generating (ID=20001) Radius (ID=20004) Send sms to (ID=7030) SMS Text (ID=8030)	Uint8

9.7.3 Activation Timeout (ID=20003)

Parameter represents AutoGeofencing activation timeout in seconds.

Minimum value	Maximum value	Default value	Goes with (depends on) parameters	Value type
0	65535	60	AutoGeofencing priority (ID=20000) Eventual Records (ID=20002) Deactivate by (ID=20005) AutoGeofence event generating (ID=20001) Radius (ID=20004) Send sms to (ID=7030) SMS Text (ID=8030)	Uint16

9.7.4 Deactivate by (ID=20005)

Parameter defines Autogeofence deactivation source. Value 0 - Power Voltage, 1 - Digital Input 1, 2 – Engine RPM, 3 – Digital Input 2¹, 4 – Digital input 3², 5 – iButton.

Minimum value	Maximum value	Default value	Goes with (depends on) parameters	Value type
0	5	0	AutoGeofencing priority	Uint8

¹ Only with FMB120 and FMB122 devices

² Only with FMB120 and FMB122 devices

			(ID=20000) Eventual Records (ID=20002) Activation Timeout (ID=20003) AutoGeofence event generating (ID=20001) Radius (ID=20004) Send sms to (ID=7030) SMS Text (ID=8030) iButton List (ID=30000 – 30500)	
--	--	--	---	--

9.7.5 AutoGeofence event generating (ID=20001)

Generate event: 0 – on exiting zone , 1 – on entering zone; 2 – on both;

Minimum value	Maximum value	Default value	Goes with (depends on) parameters	Value type
0	2	0	AutoGeofencing priority (ID=20000) Eventual Records (ID=20002) Activation Timeout (ID=20003) Deactivate by (ID=20005) Radius (ID=20004) Send sms to (ID=7030) SMS Text (ID=8030)	Uint8

9.7.6 Radius (ID=20004)

Parameter represents radius of circle with center device coordinates after activating AutoGeofence feature.

Minimum value	Maximum value	Default value	Goes with (depends on) parameters	Value type
0	1000000	100	AutoGeofencing priority (ID=20000) Eventual Records (ID=20002) Activation Timeout (ID=20003) Deactivate by (ID=20005) AutoGeofence event generating (ID=20001) Send sms to (ID=7030) SMS Text (ID=8030)	Uint32

9.7.7 AutoGeofence Send SMS to (ID=7030)

Enable/disable sms event sending. 0 – Disable, 1-10 – sms will be sent to configured GSM number.

Minimum value	Maximum value	Default value	Goes with (depends on) parameters	Value type
0	10	0	AutoGeofencing priority	U64

			(ID=20000) Eventual Records (ID=20002) Activation Timeout (ID=20003) Deactivate by (ID=20005) AutoGeofence event generating (ID=20001) Radius (ID=20004) SMS Text (ID=8030) GSM Predefined Numbers (ID=6000-6009)	
--	--	--	--	--

9.7.8 SMS Text (ID=8030)

Configure AutoGeofence sms event text here.

Minimum value	Maximum value	Default value	Goes with (depends on) parameters	Value type
0	160	AutoGeofence	AutoGeofencing priority (ID=20000) Eventual Records (ID=20002) Activation Timeout (ID=20003) Deactivate by (ID=20005) AutoGeofence event generating (ID=20001) Radius (ID=20004) Send sms to (ID=7030)	S8[180]

9.8 Manual Geofence

9.8.1 First Geozone parameters

First Geozone parameters configuration. All 50 geozones are configured with the same logic.

9.8.1.1 #1 Geozone Manual Geofencing priority (ID=20100)

0 – disabled, 1 – low, 2 – high, 3 – panic

Minimum value	Maximum value	Default value	Goes with (depends on) parameters	Value type
0	3	0	#1 Geozone Manual Geofence event generating (ID=20101) #1 Geozone Eventual Records (ID=20102) #1 Geozone Frame border (ID=20103)	Uint8

			#1 Geozone Shape type (ID=20104) #1 Geozone Radius (ID=20105) #1 Geozone X1 (ID=20106) #1 Geozone Y1 (ID=20107) #1 Geozone X2 (ID=20108) #1 Geozone X1 (ID=20109) #1 Geozone OverSpeeding (ID=20110) #1 Geozone Max allowed speed (ID=20111)	
--	--	--	---	--

9.8.1.2 #1 Geozone Manual Geofence event generating (ID=20101)

Generate event: 0 – No event, 1 - on exiting zone, 2 – on entering zone; 3 – on both;

Minimum value	Maximum value	Default value	Goes with (depends on) parameters	Value type
0	3	0	#1 Geozone Manual Geofencing priority (ID=20100) #1 Geozone Eventual Records (ID=20102) #1 Geozone Frame border (ID=20103) #1 Geozone Shape type (ID=20104) #1 Geozone Radius (ID=20105) #1 Geozone X1 (ID=20106) #1 Geozone Y1 (ID=20107) #1 Geozone X2 (ID=20108) #1 Geozone X1 (ID=20109) #1 Geozone OverSpeeding (ID=20110) #1 Geozone Max allowed speed (ID=20111)	Uint8

9.8.1.3 #1 Geozone Eventual Records (ID=20102)

0 – disable, include parameter to all records, 1 – enable, include parameter to record only if event was generated.

Minimum value	Maximum value	Default value	Goes with (depends on) parameters	Value type
0	1	1	#1 Geozone Manual Geofencing priority (ID=20100) #1 Geozone Manual Geofence event generating (ID=20101) #1 Geozone Frame border	Uint8

			(ID=20103) #1 Geozone Shape type (ID=20104) #1 Geozone Radius (ID=20105) #1 Geozone X1 (ID=20106) #1 Geozone Y1 (ID=20107) #1 Geozone X2 (ID=20108) #1 Geozone X1 (ID=20109) #1 Geozone OverSpeeding (ID=20110) #1 Geozone Max allowed speed (ID=20111)	
--	--	--	---	--

9.8.1.4 #1 Geozone Frame border (ID=20103)

Frame border is an additional border around Geofence zone.

Minimum value	Maximum value	Default value	Goes with (depends on) parameters	Value type
0	1000000	1	#1 Geozone Manual Geofencing priority (ID=20100) #1 Geozone Manual Geofence event generating (ID=20101) #1 Geozone Eventual Records (ID=20102) #1 Geozone Shape type (ID=20104) #1 Geozone Radius (ID=20105) #1 Geozone X1 (ID=20106) #1 Geozone Y1 (ID=20107) #1 Geozone X2 (ID=20108) #1 Geozone X1 (ID=20109) #1 Geozone OverSpeeding (ID=20110) #1 Geozone Max allowed speed (ID=20111)	Uint32

9.8.1.5 #1 Geozone Shape type (ID=20104)

Shape type: 0 – Circle, 1 - Rectangle.

Minimum value	Maximum value	Default value	Goes with (depends on) parameters	Value type
0	1	0	#1 Geozone Manual Geofencing priority (ID=20100) #1 Geozone Manual Geofence event generating (ID=20101) #1 Geozone Eventual Records	Uint8

			(ID=20102) #1 Geozone Frame border (ID=20103) #1 Geozone Radius (ID=20105) #1 Geozone X1 (ID=20106) #1 Geozone Y1 (ID=20107) #1 Geozone X2 (ID=20108) #1 Geozone X1 (ID=20109) #1 Geozone OverSpeeding (ID=20110) #1 Geozone Max allowed speed (ID=20111)	
--	--	--	---	--

9.8.1.6 #1 Geozone Radius (ID=20105)

Radius of circle when circular zone is used (radius in meters).

Minimum value	Maximum value	Default value	Goes with (depends on) parameters	Value type
5	1000000	5	#1 Geozone Manual Geofencing priority (ID=20100) #1 Geozone Manual Geofence event generating (ID=20101) #1 Geozone Eventual Records (ID=20102) #1 Geozone Frame border (ID=20103) #1 Geozone Shape type (ID=20104) #1 Geozone X1 (ID=20106) #1 Geozone Y1 (ID=20107) #1 Geozone X2 (ID=20108) #1 Geozone X1 (ID=20109) #1 Geozone OverSpeeding (ID=20110) #1 Geozone Max allowed speed (ID=20111)	UInt32

9.8.1.7 #1 Geozone X1 (ID=20106)

Geofence zone left bottom corner X coordinate (longitude).

Minimum value	Maximum value	Default value	Goes with (depends on) parameters	Value type
-180	180	0	#1 Geozone Manual Geofencing priority (ID=20100) #1 Geozone Manual Geofence event generating (ID=20101) #1 Geozone Eventual Records (ID=20102)	Double

			#1 Geozone Frame border (ID=20103) #1 Geozone Shape type (ID=20104) #1 Geozone Radius (ID=20105) #1 Geozone Y1 (ID=20107) #1 Geozone X2 (ID=20108) #1 Geozone X1 (ID=20109) #1 Geozone OverSpeeding (ID=20110) #1 Geozone Max allowed speed (ID=20111)	
--	--	--	---	--

9.8.1.8 #1 Geozone Y1 (ID=20107)

Geofence zone left bottom corner Y coordinate (latitude).

Minimum value	Maximum value	Default value	Goes with (depends on) parameters	Value type
-90	90	0	#1 Geozone Manual Geofencing priority (ID=20100) #1 Geozone Manual Geofence event generating (ID=20101) #1 Geozone Eventual Records (ID=20102) #1 Geozone Frame border (ID=20103) #1 Geozone Shape type (ID=20104) #1 Geozone Radius (ID=20105) #1 Geozone X1 (ID=20106) #1 Geozone X2 (ID=20108) #1 Geozone X1 (ID=20109) #1 Geozone OverSpeeding (ID=20110) #1 Geozone Max allowed speed (ID=20111)	Double

9.8.1.9 #1 Geozone X2 (ID=20108)

Geofence zone upper right corner X coordinate (longitude).

Minimum value	Maximum value	Default value	Goes with (depends on) parameters	Value type
-180	180	0	#1 Geozone Manual Geofencing priority (ID=20100) #1 Geozone Manual Geofence event generating (ID=20101) #1 Geozone Eventual Records (ID=20102)	Double

			#1 Geozone Frame border (ID=20103) #1 Geozone Shape type (ID=20104) #1 Geozone Radius (ID=20105) #1 Geozone X1 (ID=20106) #1 Geozone Y1 (ID=20107) #1 Geozone X1 (ID=20109) #1 Geozone OverSpeeding (ID=20110) #1 Geozone Max allowed speed (ID=20111)	
--	--	--	---	--

9.8.1.10 #1 Geozone X1 (ID=20109)

Geofence zone upper right corner Y coordinate (latitude).

Minimum value	Maximum value	Default value	Goes with (depends on) parameters	Value type
-90	90	0	#1 Geozone Manual Geofencing priority (ID=20100) #1 Geozone Manual Geofence event generating (ID=20101) #1 Geozone Eventual Records (ID=20102) #1 Geozone Frame border (ID=20103) #1 Geozone Shape type (ID=20104) #1 Geozone Radius (ID=20105) #1 Geozone X1 (ID=20106) #1 Geozone Y1 (ID=20107) #1 Geozone X2 (ID=20108) #1 Geozone OverSpeeding (ID=20110) #1 Geozone Max allowed speed (ID=20111)	Double

9.8.1.11 #1 Geozone OverSpeeding (ID=20110)

Enable/disable overspeeding event in geozone.

Minimum value	Maximum value	Default value	Goes with (depends on) parameters	Value type
0	1	0	#1 Geozone Manual Geofencing priority (ID=20100) #1 Geozone Manual Geofence event generating (ID=20101) #1 Geozone Eventual Records	Uint8

			(ID=20102) #1 Geozone Frame border (ID=20103) #1 Geozone Shape type (ID=20104) #1 Geozone Radius (ID=20105) #1 Geozone X1 (ID=20106) #1 Geozone Y1 (ID=20107) #1 Geozone X2 (ID=20108) #1 Geozone X1 (ID=20109) #1 Geozone Max allowed speed (ID=20111)	
--	--	--	---	--

9.8.1.12 #1 Geozone Max allowed speed (ID=20111)

It is max allowed speed which can be reached in geozone (km/h).

Minimum value	Maximum value	Default value	Goes with (depends on) parameters	Value type
0	1000	90	#1 Geozone Manual Geofencing priority (ID=20100) #1 Geozone Manual Geofence event generating (ID=20101) #1 Geozone Eventual Records (ID=20102) #1 Geozone Frame border (ID=20103) #1 Geozone Shape type (ID=20104) #1 Geozone Radius (ID=20105) #1 Geozone X1 (ID=20106) #1 Geozone Y1 (ID=20107) #1 Geozone X2 (ID=20108) #1 Geozone X1 (ID=20109) #1 Geozone OverSpeeding (ID=20110)	Uint16

9.8.2 Other Geozones

Other Geozone's parameters have the same logic as shown in Geozone #1.

GeoFence Zone Number	Geofence Zone's parameters
1	20100-20111
2	20120-20131

3	20140-20151
...	...
49	21060-21071
50	21080-21091

9.8.2.1 Send sms to #1-5 Geozone (ID=7025-7029), #6-50 Geozone (ID=7071-7115)

Enable/disable sms event sending. 0 – Disable, 1-10 – sms will be sent to configured GSM number.

Minimum value	Maximum value	Default value	Goes with (depends on) parameters	Value type
0	10	0	GSM Predefined Numbers (ID=6000-6009) SMS Text #1-5 Geozone (ID=8025-8029), #6-50 Geozone (ID=8071-8115)	Uint8

9.8.2.2 SMS Text #1-5 Geozone (ID=8025-8029), #6-50 Geozone (ID=8071-8115)

Configure geozone # sms event text here.

Minimum value	Maximum value	Default value	Goes with (depends on) parameters	Value type
0	160	Geozone Zone #	Send sms to #1-5 Geozone (ID=7025-7029), #6-50 Geozone (ID=7071-7115)	S8[160]

9.9 GPS Fuel counter

This functionality is meant to calculate fuel consumption based on set consumption values in different situations.

9.9.1 City Consumption L/100km (ID=11900)

Consumption in the city

Minimum value	Maximum value	Default value	Goes with (depends on) parameters	Value type
0	50	0	Highway Consumption L/100km (ID=11901) Average Consumption L/100km (ID=11902) City Speed [km/h] (ID=11903) Highway Speed [km/h] (ID=11904) Average Speed [km/h] (ID=11905)	Double

			Correction coefficient (ID=11906) Fuel Consumption on Idling [L/h] (ID=11907) Higher Speeds Add [%] (ID=11908) Highway Consumption every km/h (ID=11909)	
--	--	--	---	--

9.9.2 Highway Consumption L/100km (ID=11901)

Consumption on highway

Minimum value	Maximum value	Default value	Goes with (depends on) parameters	Value type
0	50	0	City Consumption L/100km (ID=11900) Average Consumption L/100km (ID=11902) City Speed [km/h] (ID=11903) Highway Speed [km/h] (ID=11904) Average Speed [km/h] (ID=11905) Correction coefficient (ID=11906) Fuel Consumption on Idling [L/h] (ID=11907) Higher Speeds Add [%] (ID=11908) Highway Consumption every km/h (ID=11909)	Double

9.9.3 Average Consumption L/100km (ID=11902)

Average fuel consumption of the vehicle

Minimum value	Maximum value	Default value	Goes with (depends on) parameters	Value type
0	50	0	City Consumption L/100km (ID=11900) Highway Consumption L/100km (ID=11901) City Speed [km/h] (ID=11903) Highway Speed [km/h] (ID=11904) Average Speed [km/h] (ID=11905)	Double

			Correction coefficient (ID=11906) Fuel Consumption on Idling [L/h] (ID=11907) Higher Speeds Add [%] (ID=11908) Highway Consumption every km/h (ID=11909)	
--	--	--	---	--

9.9.4 City Speed [km/h] (ID=11903)

Speed in the city

Minimum value	Maximum value	Default value	Goes with (depends on) parameters	Value type
0	250	30	City Consumption L/100km (ID=11900) Highway Consumption L/100km (ID=11901) Average Consumption L/100km (ID=11902) Highway Speed [km/h] (ID=11904) Average Speed [km/h] (ID=11905) Correction coefficient (ID=11906) Fuel Consumption on Idling [L/h] (ID=11907) Higher Speeds Add [%] (ID=11908) Highway Consumption every km/h (ID=11909)	Unit64

9.9.5 Highway Speed [km/h] (ID=11904)

Speed on highway

Minimum value	Maximum value	Default value	Goes with (depends on) parameters	Value type
0	250	90	City Consumption L/100km (ID=11900) Highway Consumption L/100km (ID=11901) Average Consumption L/100km (ID=11902) City Speed [km/h] (ID=11903) Average Speed [km/h]	Unit64

			(ID=11905) Correction coefficient (ID=11906) Fuel Consumption on Idling [L/h] (ID=11907) Higher Speeds Add [%] (ID=11908) Highway Consumption every km/h (ID=11909)	
--	--	--	---	--

9.9.6 Average Speed [km/h] (ID=11905)

Average speed of the vehicle

Minimum value	Maximum value	Default value	Goes with (depends on) parameters	Value type
0	250	60	City Consumption L/100km (ID=11900) Highway Consumption L/100km (ID=11901) Average Consumption L/100km (ID=11902) City Speed [km/h] (ID=11903) Highway Speed [km/h] (ID=11904) Correction coefficient (ID=11906) Fuel Consumption on Idling [L/h] (ID=11907) Higher Speeds Add [%] (ID=11908) Highway Consumption every km/h (ID=11909)	Unit64

9.9.7 Correction coefficient (ID=11906)

Correction coefficient is use for correction every value of fuel consumption which is send to server (Used Fuel * Correction coefficient).

Minimum value	Maximum value	Default value	Goes with (depends on) parameters	Value type
0.01	2	1	City Consumption L/100km (ID=11900) Highway Consumption L/100km (ID=11901) Average Consumption L/100km (ID=11902)	Double

			City Speed [km/h] (ID=11903) Highway Speed [km/h] (ID=11904) Average Speed [km/h] (ID=11905) Fuel Consumption on Idling [L/h] (ID=11907) Higher Speeds Add [%] (ID=11908) Highway Consumption every km/h (ID=11909)	
--	--	--	--	--

9.9.8 Fuel Consumption on Idling [L/h] (ID=11907)

Sets fuel consumption while vehicle is idling

Minimum value	Maximum value	Default value	Goes with (depends on) parameters	Value type
0	5	1	City Consumption L/100km (ID=11900) Highway Consumption L/100km (ID=11901) Average Consumption L/100km (ID=11902) City Speed [km/h] (ID=11903) Highway Speed [km/h] (ID=11904) Average Speed [km/h] (ID=11905) Correction coefficient (ID=11906) Higher Speeds Add [%] (ID=11908) Highway Consumption every km/h (ID=11909)	Double

9.9.9 Higher Speeds Add [%] (ID=11908)

Minimum value	Maximum value	Default value	Goes with (depends on) parameters	Value type
0	250	20	City Consumption L/100km (ID=11900) Highway Consumption L/100km (ID=11901) Average Consumption L/100km (ID=11902) City Speed [km/h] (ID=11903)	Uint64

			Highway Speed [km/h] (ID=11904) Average Speed [km/h] (ID=11905) Correction coefficient (ID=11906) Fuel Consumption on Idling [L/h] (ID=11907) Highway Consumption every km/h (ID=11909)	
--	--	--	--	--

9.9.10 Highway Consumption every km/h (ID=11909)

Minimum value	Maximum value	Default value	Goes with (depends on) parameters	Value type
0	100	50	City Consumption L/100km (ID=11900) Highway Consumption L/100km (ID=11901) Average Consumption L/100km (ID=11902) City Speed [km/h] (ID=11903) Highway Speed [km/h] (ID=11904) Average Speed [km/h] (ID=11905) Correction coefficient (ID=11906) Fuel Consumption on Idling [L/h] (ID=11907) Higher Speeds Add [%] (ID=11908)	Uint64

9.10 Accelerometer Features

9.10.1 Unplug Detection

9.10.1.1 Scenario settings (ID=11500)

Sets priority of the scenario: 0 – Disable, 1 – Low Priority, 2 – High Priority, 3 – Panic Priority

Minimum value	Maximum value	Default value	Goes with (depends on) parameters	Value type
0	3	0	Eventual records (ID=11501) Unplug detection mode (ID=11502) Send sms to (ID=7067)	Uint8

			SMS Text (ID=8067)	
--	--	--	--------------------	--

9.10.1.2 Eventual records (ID=11501)

If enabled, only eventual records of unplug detection will be sent. 0 – Disable, 1 – Enable

Minimum value	Maximum value	Default value	Goes with (depends on) parameters	Value type
0	1	1	Scenario settings (ID=11500) Unplug detection mode (ID=11502) Send sms to (ID=7067) SMS Text (ID=8067)	Uint8

9.10.1.3 Unplug detection mode (ID=11502)

Sets Unplug detection mode. 0 – simple, 1 – advanced.

Simple – unplug detection according to external voltage only

Advanced – unplug detection according to: external voltage and accelerometer

Minimum value	Maximum value	Default value	Goes with (depends on) parameters	Value type
0	1	0	Scenario settings (ID=11500) Eventual records (ID=11501) Send sms to (ID=7067) SMS Text (ID=8067)	Uint8

9.10.1.4 Unplug send sms to (ID=7067)

Enable/disable sms event sending. 0 – Disable, 1-10 – sms will be sent to configured GSM number.

Minimum value	Maximum value	Default value	Goes with (depends on) parameters	Value type
0	10	0	Scenario settings (ID=11500) Eventual records (ID=11501) Unplug detection mode (ID=11502) SMS Text (ID=8067) GSM Predefined Numbers (ID=6000-6009)	Uint8

9.10.1.5 SMS Text (ID=8067)

Configure unplug detection sms event text here.

Minimum value	Maximum value	Default value	Goes with (depends on) parameters	Value type
0	160	Unplug	Scenario settings (ID=11500) Eventual records (ID=11501) Unplug detection mode (ID=11502) Unplug send sms to (ID=7067)	S8[160]

9.10.2 Towing Detection

9.10.2.1 Scenario setting (ID=11600)

0 – disabled, 1 – low, 2 – high, 3 – panic

Minimum value	Maximum value	Default value	Goes with (depends on) parameters	Value type
0	3	0	Eventual Records (ID=11601) Activation Timeout (min) (ID=11602) Event Timeout (s) (ID=11603) Make Call(Sms Event Number ID) (ID=11604) Treshold (mg) (ID=11605) Angle (deg) (ID=11606) Duration (msec) (ID=11607) Towing Send SMS (ID=7066) SMS Text (ID=8066)	Uint8

9.10.2.2 Eventual Records (ID=11601)

Generate event: 0 – disable; 1 – enable.

Minimum value	Maximum value	Default value	Goes with (depends on) parameters	Value type
0	1	1	Scenario setting (ID=11600) Activation Timeout (min) (ID=11602) Event Timeout (s) (ID=11603) Make Call(Sms Event Number ID) (ID=11604) Treshold (mg) (ID=11605) Angle (deg) (ID=11606) Duration (msec) (ID=11607) Towing Send SMS (ID=7066) SMS Text (ID=8066)	Uint8

9.10.2.3 Activation Timeout (min) (ID=11602)

Activation timeout is time after which FMB1YX turns ON Towing detection function if other requirement is met (Ignition OFF state detected).

Minimum value	Maximum value	Default value	Goes with (depends on) parameters	Value type
0	65535	5	Scenario setting (ID=11600) Eventual Records (ID=11601) Event Timeout (s) (ID=11603) Make Call(Sms Event Number ID) (ID=11604) Treshold (mg) (ID=11605) Angle (deg) (ID=11606) Duration (msec) (ID=11607)	Uint16

			Towing Send SMS (ID=7066) SMS Text (ID=8066)	
--	--	--	---	--

9.10.2.4 Event Timeout (s) (ID=11603)

Defines time period (in second) to check ignition state when Acceleration or Angle value reach. If towing event is generated during this time period, it is skipped. It allows to filter out redundant towing event while entering car.

Minimum value	Maximum value	Default value	Goes with (depends on) parameters	Value type
0	60	0	Scenario setting (ID=11600) Eventual Records (ID=11601) Activation Timeout (min) (ID=11602) Make Call(Sms Event Number ID) (ID=11604) Treshold (mg) (ID=11605) Angle (deg) (ID=11606) Duration (msec) (ID=11607) Towing Send SMS (ID=7066) SMS Text (ID=8066)	Uint8

9.10.2.5 Towing Make Call(Sms Event Number ID) (ID=11604)

If function enabled makes call to specified phone number (configured in pre defined numbers).

Minimum value	Maximum value	Default value	Goes with (depends on) parameters	Value type
0	10	0	GSM Predefined Numbers (ID=6000-6009) Scenario setting (ID=11600) Eventual Records (ID=11601) Activation Timeout (min) (ID=11602) Event Timeout (s) (ID=11603) Treshold (mg) (ID=11605) Angle (deg) (ID=11606) Duration (msec) (ID=11607) Towing Send SMS (ID=7066) SMS Text (ID=8066)	Uint8

9.10.2.6 Treshold (mg) (ID=11605)

Value used to detect towing when ignition is OFF.

Minimum value	Maximum value	Default value	Goes with (depends on) parameters	Value type
0.1	5	0.22	Scenario setting (ID=11600) Eventual Records (ID=11601) Activation Timeout (min)	Double

			(ID=11602) Event Timeout (s) (ID=11603) Make Call(Sms Event Number ID) (ID=11604) Angle (deg) (ID=11606) Duration (msec) (ID=11607) Towing Send SMS (ID=7066) SMS Text (ID=8066)	
--	--	--	--	--

9.10.2.7 Angle (deg) (ID=11606)

Value used to detect towing when ignition is OFF.

Minimum value	Maximum value	Default value	Goes with (depends on) parameters	Value type
0.1	5	1	Scenario setting (ID=11600) Eventual Records (ID=11601) Activation Timeout (min) (ID=11602) Event Timeout (s) (ID=11603) Make Call(Sms Event Number ID) (ID=11604) Treshold (mg) (ID=11605) Duration (msec) (ID=11607) Towing Send SMS (ID=7066) SMS Text (ID=8066)	Double

9.10.2.8 Duration (msec) (ID=11607)

Defines time period to check Acceleration, angle values.

Minimum value	Maximum value	Default value	Goes with (depends on) parameters	Value type
1	5000	1000	Scenario setting (ID=11600) Eventual Records (ID=11601) Activation Timeout (min) (ID=11602) Event Timeout (s) (ID=11603) Make Call(Sms Event Number ID) (ID=11604) Treshold (mg) (ID=11605) Angle (deg) (ID=11606) Towing Send SMS (ID=7066) SMS Text (ID=8066)	Uint16

9.10.2.9 Towing Send SMS (ID=7066)

Enable/disable sms event sending. 0 – Disable, 1-10 – sms will be sent to configured GSM number.

Minimum value	Maximum value	Default value	Goes with (depends on) parameters	Value type
0	10	0	GSM Predefined Numbers (ID=6000-6009) Scenario setting (ID=11600) Eventual Records (ID=11601) Activation Timeout (min) (ID=11602) Event Timeout (s) (ID=11603) Make Call(Sms Event Number ID) (ID=11604) Treshold (mg) (ID=11605) Angle (deg) (ID=11606) Duration (msec) (ID=11607) SMS Text (ID=8066)	Uint8

9.10.2.10 SMS Text (ID=8066)

Configure Towing detection sms event text here.

Minimum value	Maximum value	Default value	Goes with (depends on) parameters	Value type
0	160	Towing	Scenario setting (ID=11600) Eventual Records (ID=11601) Activation Timeout (min) (ID=11602) Event Timeout (s) (ID=11603) Make Call(Sms Event Number ID) (ID=11604) Treshold (mg) (ID=11605) Angle (deg) (ID=11606) Duration (msec) (ID=11607) Towing Send SMS (ID=7066)	S8[180]

9.10.3 Crash Detection

9.10.3.1 Scenario settings (ID=11400)

Sets priority of the scenario: 0 – Disable, 1 – Low Priority, 2 – High Priority, 3 – Panic Priority

Minimum value	Maximum value	Default value	Goes with (depends on) parameters	Value type
0	3	0	Duration [ms] (ID=11401) Treshold [mG] (ID=11402) Crash trace (ID=11406) Crash sms send to (ID=7068) SMS Text (ID=8068)	Uint8

9.10.3.2 Duration [ms] (ID=11401)

Minimum value	Maximum value	Default value	Goes with (depends on) parameters	Value type
0	1000	5	Scenario settings (ID=11400) Treshold [mG] (ID=11402) Crash trace (ID=11406) Crash sms send to (ID=7068) SMS Text (ID=8068)	Uint8

9.10.3.3 Treshold [mG] (ID=11402)

Minimum value	Maximum value	Default value	Goes with (depends on) parameters	Value type
0	7900	1500	Scenario settings (ID=11400) Duration [ms] (ID=11401) Crash trace (ID=11406) Crash sms send to (ID=7068) SMS Text (ID=8068)	Uint16

9.10.3.4 Crash trace (ID=11406)

Minimum value	Maximum value	Default value	Goes with (depends on) parameters	Value type
0	1	0	Scenario settings (ID=11400) Duration [ms] (ID=11401) Treshold [mG] (ID=11402) Crash sms send to (ID=7068) SMS Text (ID=8068)	Uint8

9.10.3.5 Crash sms send to (ID=7068)

Enable/disable sms event sending. 0 – Disable, 1-10 – sms will be sent to configured GSM number.

Minimum value	Maximum value	Default value	Goes with (depends on) parameters	Value type
0	10	0	GSM Predefined Numbers (ID=6000-6009) Scenario settings (ID=11400) Duration [ms] (ID=11401) Treshold [mG] (ID=11402) Crash trace (ID=11406) SMS Text (ID=8068)	Uint8

9.10.3.6 SMS Text (ID=8068)

Configure Crash sms event text here.

Minimum value	Maximum value	Default value	Goes with (depends on) parameters	Value type
0	160	Crash	Scenario settings (ID=11400) Duration [ms] (ID=11401) Treshold [mG] (ID=11402) Crash trace (ID=11406) Crash sms send to (ID=7068)	S8[160]

9.10.4 Excessive idling

9.10.4.1 Excessive idling priority (ID=11200)

Defines priority of Excessive idling scenario:

0 – disabled, 1 – low, 2 – high, 3 – panic

Minimum value	Maximum value	Default value	Goes with (depends on) parameters	Value type
0	3	0	Eventual records (ID=11203) Excessive idling minimum stop duration (ID=11205) Excessive idling minimum move duration (ID=11206) Excessive idling output control (ID=11204) Excessive idling output on duration (ID=11201) Excessive idling output off duration (ID=11202) Excessive idling Send SMS To (ID=7033) Excessive idling SMS Text (ID=8033)	UInt8

9.10.4.2 Eventual records (ID=11203)

Disables (0) or enables (1) eventual records with idling value.

Minimum value	Maximum value	Default value	Goes with (depends on) parameters	Value type
0	1	1	Excessive idling priority (ID=11200) Excessive idling minimum stop duration (ID=11205) Excessive idling minimum move duration (ID=11206) Excessive idling output control (ID=11204)	UInt8

			Excessive idling output on duration (ID=11201) Excessive idling output off duration (ID=11202) Excessive idling Send SMS To (ID=7033) Excessive idling SMS Text (ID=8033)	
--	--	--	--	--

9.10.4.3 Excessive idling time to stopped (ID=11205)

Defines minimum time in seconds of vehicle idling before scenario enables.

Minimum value	Maximum value	Default value	Goes with (depends on) parameters	Value type
0	3600	300	Excessive idling priority (ID=11200) Eventual records (ID=11203) Excessive idling minimum move duration (ID=11206) Excessive idling output control (ID=11204) Excessive idling output on duration (ID=11201) Excessive idling output off duration (ID=11202) Excessive idling Send SMS To (ID=7033) Excessive idling SMS Text (ID=8033)	UInt8

9.10.4.4 Excessive idling time to moving (ID=11206)

Defines minimum time in seconds of vehicle idling before scenario disables.

Minimum value	Maximum value	Default value	Goes with (depends on) parameters	Value type
0	3600	5	Excessive idling priority (ID=11200) Eventual records (ID=11203) Excessive idling minimum stop duration (ID=11205) Excessive idling output control (ID=11204) Excessive idling output on duration (ID=11201) Excessive idling output off duration (ID=11202) Excessive idling Send SMS To (ID=7033) Excessive idling SMS Text (ID=8033)	UInt8

9.10.4.5 Excessive idling output control (ID=11204)

Enables DOUT1 (1), enables DOUT2 (2)¹ or disables (0) Excessive idling output control.

Minimum value	Maximum value	Default value	Goes with (depends on) parameters	Value type
0	2 (1 ²)	0	Excessive idling priority (ID=11200) Eventual records (ID=11203) Excessive idling minimum stop duration (ID=11205) Excessive idling minimum move duration (ID=11206) Excessive idling output on duration (ID=11201) Excessive idling output off duration (ID=11202) Excessive idling Send SMS To (ID=7033) Excessive idling SMS Text (ID=8033)	UInt8

¹ Only with FMB120 and FMB122 devices

² Max value with FMB125 is 1.

9.10.4.6 Excessive idling output on duration (ID=11201)
Output ON duration in seconds

Minimum value	Maximum value	Default value	Goes with (depends on) parameters	Value type
100	5000	200	Excessive idling priority (ID=11200) Eventual records (ID=11203) Excessive idling minimum stop duration (ID=11205) Excessive idling minimum move duration (ID=11206) Excessive idling output control (ID=11204) Excessive idling output off duration (ID=11202) Excessive idling Send SMS To (ID=7033) Excessive idling SMS Text (ID=8033)	Int32

9.10.4.7 Excessive idling output off duration (ID=11202)
Output OFF duration in seconds

Minimum value	Maximum value	Default value	Goes with (depends on) parameters	Value type
0	5000	200	Excessive idling priority (ID=11200) Eventual records (ID=11203) Excessive idling minimum stop duration (ID=11205) Excessive idling minimum move duration (ID=11206) Excessive idling output control (ID=11204) Excessive idling output on duration (ID=11201) Excessive idling Send SMS To (ID=7033) Excessive idling SMS Text (ID=8033)	Int32

9.10.4.8 Excessive idling Send SMS To (ID=7033)

Enable/disable sms event sending. 0 – Disable, 1-10 – sms will be sent to configured GSM number.

Minimum value	Maximum value	Default value	Goes with (depends on) parameters	Value type
0	10	0	GSM Predefined Numbers (ID=6000-6009) Excessive idling priority (ID=11200) Eventual records (ID=11203) Excessive idling minimum stop duration (ID=11205) Excessive idling minimum move duration (ID=11206) Excessive idling output control (ID=11204) Excessive idling output on duration (ID=11201) Excessive idling output off duration (ID=11202) Excessive idling SMS Text (ID=8033)	UInt8

9.10.4.9 Excessive idling SMS Text (ID=8033)

Configure excessive idling sms event text here.

Minimum value	Maximum value	Default value	Goes with (depends on) parameters	Value type
0	160	Idling Event	Excessive idling priority (ID=11200) Eventual records (ID=11203) Excessive idling minimum stop duration (ID=11205) Excessive idling minimum move duration (ID=11206) Excessive idling output control (ID=11204) Excessive idling output on duration (ID=11201) Excessive idling output off duration (ID=11202) Excessive idling Send SMS To (ID=7033)	S8[160]

9.11 Bluetooth

9.11.1.1 BT Radio (ID=800)

Enables or disable Bluetooth feature. 0 – Disabled, 1 – Enable hidden, 2 – Enable visible

Minimum value	Maximum value	Default value	Goes with (depends on) parameters	Value type
0	2	0	Local name (ID 801) Local PIN (ID=802) Security mode (ID=803) External MAC (ID=804) External name (ID=805) External PIN (ID=806) Connection mode (ID=807) Authorized devices MAC list (ID=830 - 834)	Uint8

9.11.1.2 Local name (ID 801)

Parameter defines a visible name of FMB1YX device.

Minimum value	Maximum value	Default value	Goes with (depends on) parameters	Value type
0 Symbols	30 Symbols	FMB1YX_(last 7 IMEI numbers)	BT Radio (ID=800) Local PIN (ID=802) Security mode (ID=803) External MAC (ID=804) External name (ID=805) External PIN (ID=806) Connection mode (ID=807) Authorized devices MAC list (ID=830 - 834)	S8[30]

9.11.1.3 Local PIN (ID=802)

Parameter Lets to configure Bluetooth PIN.

Minimum value	Maximum value	Default value	Goes with (depends on) parameters	Value type
0 Symbols	4 Symbols	5555	BT Radio (ID=800) Local name (ID 801) Security mode (ID=803) External MAC (ID=804) External name (ID=805) External PIN (ID=806) Connection mode (ID=807) Authorized devices MAC list (ID=830 - 834)	String

9.11.1.4 Security mode (ID=803)

Parameter defines a security mode of FMBX device. 0 – PIN only, 1 – PIN and MAC, 2 – MAC only, 3 – None.

Minimum value	Maximum value	Default value	Goes with (depends on) parameters	Value type
0	3	0	BT Radio (ID=800) Local name (ID 801) Local PIN (ID=802) External MAC (ID=804) External name (ID=805) External PIN (ID=806) Connection mode (ID=807) Authorized devices MAC list (ID=830 - 834)	Uint8

9.11.1.5 External MAC (ID=804)

Defines external device's MAC, for FMB1YX to auto connect to.

Minimum value	Maximum value	Default value	Goes with (depends on) parameters	Value type
0 symbols	12 symbols	0	BT Radio (ID=800) Local name (ID 801) Local PIN (ID=802) Security mode (ID=803) External name (ID=805) External PIN (ID=806) Connection mode (ID=807) Authorized devices MAC list (ID=830 - 834)	string

9.11.1.6 External name (ID=805)

Defines external device's name, for FMB1YX to auto connect to.

Minimum value	Maximum value	Default value	Goes with (depends on) parameters	Value type
0 symbols	30 symbols	0	BT Radio (ID=800) Local name (ID 801) Local PIN (ID=802) Security mode (ID=803) External MAC (ID=804) External PIN (ID=806) Connection mode (ID=807) Authorized devices MAC list (ID=830 - 834)	string

9.11.1.7 External PIN (ID=806)

Defines external device's PIN, for FMB1YX to auto connect to.

Minimum value	Maximum value	Default value	Goes with (depends on) parameters	Value type
0 symbols	8 symbols	0	BT Radio (ID=800) Local name (ID 801)	string

			Local PIN (ID=802) Security mode (ID=803) External MAC (ID=804) External name (ID=805) Connection mode (ID=807) Authorized devices MAC list (ID=830 - 834)	
--	--	--	---	--

9.11.1.8 Connection mode (ID=807)

Defines a mode in which FMB1YX will connect to external devices. 0 – None,

1 – FMB1YX will connect to Hands Free Headset, 2 – FMB1YX will connect to OBDII Bluetooth dongle, 3 – Data Link.

Minimum value	Maximum value	Default value	Goes with (depends on) parameters	Value type
0	3	0	BT Radio (ID=800) Local name (ID 801) Local PIN (ID=802) Security mode (ID=803) External MAC (ID=804) External name (ID=805) External PIN (ID=806) Authorized devices MAC list (ID=830 - 834)	Uint8

9.11.1.9 Authorized devices MAC list (ID=830 - 834)

Parameter allows to add an authorized devices MAC for connection to FMB1YX

Minimum value	Maximum value	Default value	Goes with (depends on) parameters	Value type
0 symbols	12 symbols	-	BT Radio (ID=800) Local name (ID 801) Local PIN (ID=802) Security mode (ID=803) External MAC (ID=804) External name (ID=805) External PIN (ID=806) Connection mode (ID=807)	String

9.12 iButton List (ID=30000 – 30500)

List of 500 authorized iButtons' IDs.

Minimum value	Maximum value	Default value	Goes with (depends on) parameters	Value type
0	FFFFFFFF FFFFFFFF	0	Deactivate by (ID=20005) iButton list check (ID=11703) Remember iButton ID (ID=11805)	Uint64

9.13 I/O parameters

I/O properties are additional data sources which are recorded along with usual GPS data.

9.13.1 I/O#1 property parameter priority Ignition (ID=50000)

Parameter defines I/O property type of priority: 0 is disabled, 1 – low, 2 – high, 3 - panic.

Minimum value	Maximum value	Default value	Goes with (depends on) parameters	Value type
0	3	1	I/O#1 operand (ID=50001) I/O#1 High level (ID=50002) I/O#1 Low level (ID=50003) I/O#1 Event only (ID=50004) I/O#1 averaging length (ID=50005) I/O#1 send SMS (ID=7000) I/O#1 SMS text (ID=8000)	Uint8

9.13.2 I/O#1 operand (ID=50001)

Parameter defines when event is sent: 0 – on range exit, 1 – on range entrance, 2 – both, 3 – monitoring, 4 – hysteresis, 5 – on changes, 6 – on delta change.

Minimum value	Maximum value	Default value	Goes with (depends on) parameters	Value type
0	6	0	I/O#1 property parameter priority Ignition (ID=50000) I/O#1 High level (ID=50002) I/O#1 Low level (ID=50003) I/O#1 Event only (ID=50004) I/O#1 averaging length (ID=50005) I/O#1 send SMS (ID=7000) I/O#1 SMS text (ID=8000)	Uint8

9.13.3 I/O#1 High level (ID=50002)

Parameter defines high value of triggered I/O property. This parameter is used to set thresholds for I/O properties to generate events.

Minimum value	Maximum value	Default value	Goes with (depends on) parameters	Value type
0	1	0	I/O#1 property parameter priority Ignition (ID=50000) I/O#1 operand (ID=50001) I/O#1 Low level (ID=50003) I/O#1 Event only (ID=50004) I/O#1 averaging length (ID=50005) I/O#1 send SMS (ID=7000) I/O#1 SMS text (ID=8000)	Uint8

9.13.4 I/O#1 Low level (ID=50003)

Parameter defines low value of triggered I/O property. This parameter is used to set thresholds for I/O properties to generate events.

Minimum value	Maximum value	Default value	Goes with (depends on) parameters	Value type
0	1	0	I/O#1 property parameter priority Ignition (ID=50000) I/O#1 operand (ID=50001) I/O#1 High level (ID=50002) I/O#1 Event only (ID=50004) I/O#1 averaging length (ID=50005) I/O#1 send SMS (ID=7000) I/O#1 SMS text (ID=8000)	Uint8

9.13.5 I/O#1 Event only (ID=50004)

Parameter defines when IO element value is sent: 0 – with every AVL packet, 1 – on event only. On event means that IO element value is included to AVL packet only when this particular event happens. With regular, periodic records such IO element value is not included.

Minimal value	Maximum value	Default value	Goes with (depends on) parameters	Value type
0	1	0	I/O#1 property parameter priority Ignition (ID=50000) I/O#1 operand (ID=50001) I/O#1 High level (ID=50002) I/O#1 Low level (ID=50003) I/O#1 averaging length (ID=50005) I/O#1 send SMS (ID=7000) I/O#1 SMS text (ID=8000)	Uint8

9.13.6 I/O#1 averaging length (ID=50005)

Parameter defines I/O property sample length to average.

Minimum value	Maximum value	Default value	Goes with (depends on) parameters	Value type
0	65535	10	I/O#1 property parameter priority Ignition (ID=50000) I/O#1 operand (ID=50001) I/O#1 High level (ID=50002) I/O#1 Low level (ID=50003) I/O#1 Event only (ID=50004) I/O#1 send SMS (ID=7000) I/O#1 SMS text (ID=8000)	Uint16

9.13.7 I/O#1 send SMS (ID=7000)

Enable/disable sms event sending. 0 – Disable, 1-10 – sms will be sent to configured GSM number.

Minimum value	Maximum value	Default value	Goes with (depends on) parameters	Value type
0	10	0	GSM Predefined Numbers (ID=6000-6009) I/O#1 property parameter priority Ignition (ID=50000) I/O#1 operand (ID=50001) I/O#1 High level (ID=50002) I/O#1 Low level (ID=50003) I/O#1 Event only (ID=50004) I/O#1 SMS text (ID=8000)	Uint8

9.13.8 I/O#1 SMS text (ID=8000)

Configure I/O#1 sms event text here.

Minimum value	Maximum value	Default value	Goes with (depends on) parameters	Value type
0	160	Ignition	I/O#1 property parameter priority Ignition (ID=50000) I/O#1 operand (ID=50001) I/O#1 High level (ID=50002) I/O#1 Low level (ID=50003) I/O#1 Event only (ID=50004) I/O#1 send SMS (ID=7000)	S8[160]

9.13.9 I/O elements parameters and types.

Priority: 0 – disabled, 1 – low, 2 – high, 3 – panic.

Operand: 0 – On Exit, 1 – On Entrance, 2 – On Both, 3 – Monitoring, 4 – On Hysteresis, 5 – On Change, 6 – On Delta Change.

Event only: 0 – No, 1 – Yes.

Table 20. Parameters for FMB1YX devices

Parameter ID	Parameter Type	Default value	Value range		Parameter name
			Min	Max	
50000	Uint8	1	0	3	Ignition Priority
50001	Uint8	5	0	6	Ignition Operand
50002	Uint8	0	0	1	Ignition High level
50003	Uint8	0	0	1	Ignition Low level
50004	Uint8	0	0	1	Ignition Event only
50005	Uint16	10	0	65535	Ignition Average
7000	Uint8	0	0	10	Send SMS
8000	String	0	0	160	SMS Text
50010	Uint8	1	0	3	Movement Priority

Parameter ID	Parameter Type	Default value	Value range		Parameter name
			Min	Max	
50011	Uint8	5	0	6	Movement Operand
50012	Uint8	0	0	1	Movement High level
50013	Uint8	0	0	1	Movement Low level
50014	Uint8	0	0	1	Movement Event only
50015	Uint16	1	0	65535	Movement Average
7001	Uint8	0	0	10	Send SMS
8001	String	0	0	160	SMS Text
50020	Uint8	1	0	3	Data Mode Priority
50021	Uint8	3	0	6	Data Mode Operand
50022	Uint8	0	0	5	Data Mode High level
50023	Uint8	0	0	5	Data Mode Low level
50024	Uint8	0	0	1	Data Mode Event only
7002	Uint8	0	0	10	Send SMS
8002	String	0	0	160	SMS Text
50030	Uint8	1	0	3	GSM Signal Priority
50031	Uint8	3	0	6	GSM Signal Operand
50032	Uint8	0	0	5	GSM Signal High level
50033	Uint8	0	0	5	GSM Signal Low level
50034	Uint8	0	0	1	GSM Signal Event only
50035	Uint16	1	0	65535	GSM Signal Average
7003	Uint8	0	0	10	Send SMS
8003	String	0	0	160	SMS Text
50040	Uint8	1	0	3	Deep Sleep Priority
50041	Uint8	3	0	6	Deep Sleep Operand
50042	Uint8	0	0	2	Deep Sleep High level
50043	Uint8	0	0	2	Deep Sleep Low level
50044	Uint8	0	0	1	Deep Sleep Event only
7004	Uint8	0	0	10	Send SMS
8004	String	0	0	160	SMS Text
50050	Uint8	1	0	3	GNSS Status Priority
50051	Uint8	3	0	6	GNSS Status Operand
50052	Uint8	0	0	5	GNSS Status High level
50053	Uint8	0	0	5	GNSS Status Low level
50053	Uint8	0	0	1	GNSS Status Event only
7005	Uint8	0	0	10	Send SMS
8005	String	0	0	160	SMS Text
50060	Uint8	0	0	3	GNSS PDOP Priority
5061	Uint8	3	0	6	GNSS PDOP Operand
5062	Uint16	0	0	1000	GNSS PDOP High level
5063	Uint16	0	0	1000	GNSS PDOP Low level
5064	Uint8	0	0	1	GNSS PDOP Event only
5065	Uint16	10	0	65535	GNSS PDOP Average
7006	Uint8	0	0	10	Send SMS
8006	String	0	0	160	SMS Text
50070	Uint8	1	0	3	GNSS HDOP Priority
50071	Uint8	3	0	6	GNSS HDOP Operand
50072	Uint16	0	0	1000	GNSS HDOP High level

Parameter ID	Parameter Type	Default value	Value range		Parameter name
			Min	Max	
50073	Uint16	0	0	1000	GNSS HDOP Low level
50074	Uint8	0	0	1	GNSS HDOP Event only
50075	Uint16	10	0	65535	GNSS HDOP Average
7007	Uint8	0	0	10	Send SMS
8007	String	0	0	160	SMS Text
50080	Uint8	1	0	3	External Voltage Priority
50081	Uint8	6	0	6	External Voltage Operand
50082	Uint16	1000	0	60000	External Voltage High level
50083	Uint16	0	0	60000	External Voltage Low level
50084	Uint8	0	0	1	External Voltage Event only
50085	Uint16	10	0	65535	External Voltage Average
7008	Uint8	0	0	10	Send SMS
8008	String	0	0	160	SMS Text
50090	Uint8	1	0	3	Speed Priority
50091	Uint8	3	0	6	Speed Operand
50092	Uint16	0	0	300	Speed High level
50093	Uint16	0	0	300	Speed Low level
50094	Uint8	0	0	1	Speed Event only
50095	Uint16	1	0	65535	Speed Average
7009	Uint8	0	0	10	Send SMS
8009	String	0	0	160	SMS Text
50100	Uint8	0	0	3	GSM Cell ID Priority
50101	Uint8	3	0	6	GSM Cell ID Operand
50102	Uint32	0	0	999999	GSM Cell ID High level
50103	Uint32	0	0	999999	GSM Cell ID Low level
50104	Uint8	0	0	1	GSM Cell ID Event only
7010	Uint8	0	0	10	Send SMS
8010	String	0	0	160	SMS Text
50110	Uint8	0	0	3	GSM Area Code Priority
50111	Uint8	3	0	6	GSM Area Code Operand
50112	Uint32	0	0	999999	GSM Area Code High level
50113	Uint32	0	0	999999	GSM Area Code Low level
50114	Uint8	0	0	1	GSM Area Code Event only
7011	Uint8	0	0	10	Send SMS
8011	String	0	0	160	SMS Text
50120	Uint8	1	0	3	Battery Voltage Priority
50121	Uint8	3	0	6	Battery Voltage Operand
50122	Uint16	0	0	5000	Battery Voltage High level
50123	Uint16	0	0	5000	Battery Voltage Low level
50124	Uint8	0	0	1	Battery Voltage Event only
50125	Uint8	0	0	10	Battery Voltage Average
7012	Uint8	0	0	10	Send SMS
8012	String	0	0	160	SMS Text
50130	Uint8	1	0	3	Battery Current Priority
50131	Uint8	3	0	6	Battery Current Operand
50132	Uint16	0	0	5000	Battery Current High level
50133	Uint16	0	0	5000	Battery Current Low level

Parameter ID	Parameter Type	Default value	Value range		Parameter name
			Min	Max	
50134	Uint8	0	0	1	Battery Current Event only
50135	Uint8	0	0	10	Battery Current Average
7013	Uint8	0	0	10	Send SMS
8013	String	0	0	160	SMS Text
50140	Uint8	0	0	3	Active GSM Operator Priority
50141	Uint8	3	0	6	Active GSM Operator Operand
50142	Uint32	0	0	999999	Active GSM Operator High level
50143	Uint32	0	0	999999	Active GSM Operator Low level
50144	Uint8	0	0	1	Active GSM Operator Event only
7014	Uint8	0	0	10	Send SMS
8014	String	0	0	160	SMS Text
50150	Uint8	0	0	3	Trip Odometer Priority
50151	Uint8	3	0	6	Trip Odometer Operand
50152	Uint32	0	0	1000000	Trip Odometer High level
50153	Uint32	0	0	1000000	Trip Odometer Low level
50154	Uint8	0	0	1	Trip Odometer Event only
7015	Uint8	0	0	10	Send SMS
8015	String	0	0	160	SMS Text
50160	Uint8	0	0	3	Total Odometer Priority
50161	Uint8	3	0	6	Total Odometer Operand
50162	Uint32	0	0	10000000	Total Odometer High level
50163	Uint32	0	0	10000000	Total Odometer Low level
50164	Uint8	0	0	1	Total Odometer Event only
7016	Uint8	0	0	10	Send SMS
8016	String	0	0	160	SMS Text
50170	Uint8	0	0	3	Digital Input 1 Priority
50171	Uint8	3	0	6	Digital Input 1 Operand
50172	Uint8	0	0	1	Digital Input 1 High level
50173	Uint8	0	0	1	Digital Input 1 Low level
50174	Uint8	0	0	1	Digital Input 1 Event only
50175	Uint16	1	0	65535	Digital Input 1 Average
7017	Uint8	0	0	10	Send SMS
8017	String	0	0	160	SMS Text
50180	Uint8	0	0	3	Analog Input 1 Priority
50181	Uint8	3	0	6	Analog Input 1 Operand
50182	Uint16	0	0	30000	Analog Input 1 High level
50183	Uint16	0	0	30000	Analog Input 1 Low level
50184	Uint8	0	0	1	Analog Input 1 Event only
50185	Uint16	10	0	65535	Analog Input 1 Average
7018	Uint8	0	0	10	Send SMS
8018	String	0	0	160	SMS Text
50190	Uint8	0	0	3	Digital Output 1 Priority
50191	Uint8	0	0	6	Digital Output 1 Operand
50192	Uint8	0	0	1	Digital Output 1 High level
50193	Uint8	0	0	1	Digital Output 1 Low level
50194	Uint8	0	0	1	Digital Output 1 Event only
50195	Uint16	1	0	65535	Digital Output 1 Average

Parameter ID	Parameter Type	Default value	Value range		Parameter name
			Min	Max	
7019	Uint8	0	0	10	Send SMS
8019	String	0	0	160	SMS Text
50200	Uint8	0	0	3	Fuel Used GPS Priority
50201	Uint8	3	0	6	Fuel Used GPS Operand
50202	Uint32	0	0	1000000	Fuel Used GPS High level
50203	Uint32	0	0	1000000	Fuel Used GPS Low level
50204	Uint8	0	0	1	Fuel Used GPS Event only
50205	Uint16	1	0	65535	Fuel Used GPS Average
7020	Uint8	0	0	10	Send SMS
8020	String	0	0	160	SMS Text
50210	Uint8	0	0	3	Fuel Rate GPS Priority
50211	Uint8	3	0	6	Fuel Rate GPS Operand
50212	Uint32	0	0	1000000	Fuel Rate GPS High level
50213	Uint32	0	0	1000000	Fuel Rate GPS Low level
50214	Uint8	0	0	1	Fuel Rate GPS Event only
50215	Uint16	1	0	65535	Fuel Rate GPS Average
7021	Uint8	0	0	10	Send SMS
8021	String	0	0	160	SMS Text
50220	Uint8	0	0	3	Axis X Priority
50221	Uint8	3	0	6	Axis X Operand
50222	Uint16	0	-8000	8000	Axis X High level
50223	Uint16	0	-8000	8000	Axis X Low level
50224	Uint8	0	0	1	Axis X Event only
50225	Uint16	1	0	65535	Axis X Average
7022	Uint8	0	0	10	Send SMS
8022	String	0	0	160	SMS Text
50230	Uint8	0	0	3	Axis Y Priority
50231	Uint8	3	0	6	Axis Y Operand
50232	Uint16	0	-8000	8000	Axis Y High level
50233	Uint16	0	-8000	8000	Axis Y Low level
50234	Uint8	0	0	1	Axis Y Event only
50235	Uint16	1	0	65535	Axis Y Average
7023	Uint8	0	0	10	Send SMS
8023	String	0	0	160	SMS Text
50240	Uint8	0	0	3	Axis Z Priority
50241	Uint8	3	0	6	Axis Z Operand
50242	Uint16	0	-8000	8000	Axis Z High level
50243	Uint16	0	-8000	8000	Axis Z Low level
50244	Uint8	0	0	1	Axis Z Event only
50245	Uint16	1	0	65535	Axis Z Average
7024	Uint8	0	0	10	Send SMS
8024	String	0	0	160	SMS Text
50250	Uint8	0	0	3	ICCID Priority
50251	Uint8	3	0	6	ICCID Operand
50254	Uint8	0	0	1	ICCID Event only
7069	Uint8	0	0	10	Send SMS
8069	String	0	0	160	SMS Text

Parameter ID	Parameter Type	Default value	Value range		Parameter name
			Min	Max	
50260	Uint8	0	0	3	SD Status Priority
50261	Uint8	3	0	6	SD Status Operand
50262	Uint8	0	0	1	SD Status High level
50263	Uint8	0	0	1	SD Status Low level
7070	Uint8	0	0	10	Send SMS
8070	String	0	0	160	SMS Text
50310	Uint8	0	0	3	Dallas Temperature 1 Priority
50311	Uint8	3	0	6	Dallas Temperature 1 Operand
50312	Int8	0	-55	125	Dallas Temperature 1 High level
50313	Int8	0	-55	125	Dallas Temperature 1 Low level
50314	Uint8	0	0	1	Dallas Temperature 1 Event only
50315	Uint16	0	0	65535	Dallas Temperature 1 Average
7120	Uint8	0	0	10	Send SMS
8120	String	0	0	160	SMS Text
50320	Uint8	0	0	3	Dallas Temperature 2 Priority
50321	Uint8	3	0	6	Dallas Temperature 2 Operand
50322	Int8	0	-55	125	Dallas Temperature 2 High level
50323	Int8	0	-55	125	Dallas Temperature 2 Low level
50324	Uint8	0	0	1	Dallas Temperature 2 Event only
50325	Uint16	0	0	65535	Dallas Temperature 2 Average
7121	Uint8	0	0	10	Send SMS
8121	String	0	0	160	SMS Text
50330	Uint8	0	0	3	Dallas Temperature 3 Priority
50331	Uint8	3	0	6	Dallas Temperature 3 Operand
50332	Int8	0	-55	125	Dallas Temperature 3 High level
50333	Int8	0	-55	125	Dallas Temperature 3 Low level
50334	Uint8	0	0	1	Dallas Temperature 3 Event only
50335	Uint16	0	0	65535	Dallas Temperature 3 Average
7122	Uint8	0	0	10	Send SMS
8122	String	0	0	160	SMS Text
50340	Uint8	0	0	3	Dallas Temperature 4 Priority
50341	Uint8	3	0	6	Dallas Temperature 4 Operand
50342	Int8	0	-55	125	Dallas Temperature 4 High level
50343	Int8	0	-55	125	Dallas Temperature 4 Low level
50344	Uint8	0	0	1	Dallas Temperature 4 Event only
50345	Uint16	0	0	65535	Dallas Temperature 4 Average
7123	Uint8	0	0	10	Send SMS
8123	String	0	0	160	SMS Text
50350	Uint8	0	0	3	Dallas Temperature ID 1 Priority
50351	Uint8	3	0	6	Dallas Temperature ID 1 Operand
50352	Uint32	0	0	999999999	Dallas Temperature ID 1 High level
50353	Uint32	0	0	999999999	Dallas Temperature ID 1 Low level
50354	Uint8	0	0	1	Dallas Temperature ID 1 Event only
50355	Uint16	0	0	65535	Dallas Temperature ID 1 Average
7124	Uint8	0	0	10	Send SMS
8124	String	0	0	160	SMS Text
50360	Uint8	0	0	3	Dallas Temperature ID 2 Priority

Parameter ID	Parameter Type	Default value	Value range		Parameter name
			Min	Max	
50361	Uint8	3	0	6	Dallas Temperature ID 2 Operand
50362	Uint32	0	0	999999999	Dallas Temperature ID 2 High level
50363	Uint32	0	0	999999999	Dallas Temperature ID 2 Low level
50364	Uint8	0	0	1	Dallas Temperature ID 2 Event only
50365	Uint16	0	0	65535	Dallas Temperature ID 2 Average
7125	Uint8	0	0	10	Send SMS
8125	String	0	0	160	SMS Text
50370	Uint8	0	0	3	Dallas Temperature ID 3 Priority
50371	Uint8	3	0	6	Dallas Temperature ID 3 Operand
50372	Uint32	0	0	999999999	Dallas Temperature ID 3 High level
50373	Uint32	0	0	999999999	Dallas Temperature ID 3 Low level
50374	Uint8	0	0	1	Dallas Temperature ID 3 Event only
50375	Uint16	0	0	65535	Dallas Temperature ID 3 Average
7126	Uint8	0	0	10	Send SMS
8126	String	0	0	160	SMS Text
50380	Uint8	0	0	3	Dallas Temperature ID 4 Priority
50381	Uint8	3	0	6	Dallas Temperature ID 4 Operand
50382	Uint32	0	0	999999999	Dallas Temperature ID 4 High level
50383	Uint32	0	0	999999999	Dallas Temperature ID 4 Low level
50384	Uint8	0	0	1	Dallas Temperature ID 4 Event only
50385	Uint16	0	0	65535	Dallas Temperature ID 4 Average
7127	Uint8	0	0	10	Send SMS
8127	String	0	0	160	SMS Text
50390	Uint8	0	0	3	iButton Priority
50391	Uint8	3	0	6	iButton Operand
50392	Uint32	0	0	999999999	iButton High level
50393	Uint32	0	0	999999999	iButton Low level
50394	Uint8	0	0	1	iButton Event only
50395	Uint16	0	0	65535	iButton Average
7128	Uint8	0	0	10	Send SMS
8128	String	0	0	160	SMS Text
50510	Uint8	0	0	3	Eco Score Priority
50511	Uint8	3	0	6	Eco Score Operand
50512	Uint8	0	0	1	Eco Score High level
50513	Uint8	0	0	1	Eco Score Low level
50514	Uint8	0	0	1	Eco Score Event only
7220	Uint8	0	0	10	Send SMS
8220	String	0	0	160	SMS Text

Table 21. Parameters only for FMB120 and FMB122 devices

Parameter ID	Parameter Type	Default value	Value range		Parameter name
			Min	Max	
50270	Uint8	0	0	3	Digital Input 2 Priority
50271	Uint8	3	0	6	Digital Input 2 Operand
50272	Uint8	0	0	1	Digital Input 2 High level
50273	Uint8	0	0	1	Digital Input 2 Low level
50274	Uint8	0	0	1	Digital Input 2 Event only

Parameter ID	Parameter Type	Default value	Value range		Parameter name
			Min	Max	
50275	Uint16	0	0	65535	Digital Input 2 Average
7116	Uint8	0	0	10	Send SMS
8116	String	0	0	160	SMS Text
50280	Uint8	0	0	3	Digital Input 3 Priority
50281	Uint8	3	0	6	Digital Input 3 Operand
50282	Uint8	0	0	1	Digital Input 3 High level
50283	Uint8	0	0	1	Digital Input 3 Low level
50284	Uint8	0	0	1	Digital Input 3 Event only
50285	Uint16	0	0	65535	Digital Input 3 Average
7117	Uint8	0	0	10	Send SMS
8117	String	0	0	160	SMS Text
50290	Uint8	0	0	3	Analog Input 2 Priority
50291	Uint8	3	0	6	Analog Input 2 Operand
50292	Uint16	0	0	30000	Analog Input 2 High level
50293	Uint16	0	0	30000	Analog Input 2 Low level
50294	Uint8	0	0	1	Analog Input 2 Event only
50295	Uint16	0	0	65535	Analog Input 2 Average
7117	Uint8	0	0	10	Send SMS
8117	String	0	0	160	SMS Text
50300	Uint8	0	0	3	Digital Output 2 Priority
50301	Uint8	3	0	6	Digital Output 2 Operand
50302	Uint8	0	0	1	Digital Output 2 High level
50303	Uint8	0	0	1	Digital Output 2 Low level
50304	Uint8	0	0	1	Digital Output 2 Event only
50305	Uint16	1	0	65535	Digital Output 2 Average
7119	Uint8	0	0	10	Send SMS
8119	String	0	0	160	SMS Text

Table 22. Parameters only for FMB125 device

Parameter ID	Parameter Type	Default value	Value range		Parameter name
			Min	Max	
50400	Uint8	0	0	3	RFID Priority
50401	Uint8	3	0	6	RFID Operand
50402	Uint32	0	0	999999999	RFID High level
50403	Uint32	0	0	999999999	RFID Low level
50404	Uint8	0	0	1	RFID Event only
50405	Uint16	1	0	65535	RFID Average
7129	Uint8	0	0	10	Send SMS
8129	String	0	0	160	SMS Text
50410	Uint8	0	0	3	LLS1 Fuel Level Priority
50411	Uint8	3	0	6	LLS1 Fuel Level Operand
50412	Uint16	0	0	65535	LLS1 Fuel Level High level
50413	Uint16	0	0	65535	LLS1 Fuel Level Low level
50414	Uint8	0	0	1	LLS1 Fuel Level Event only
50415	Uint16	1	0	65535	LLS1 Fuel Level Average
7130	Uint8	0	0	10	Send SMS
8130	String	0	0	160	SMS Text

Parameter ID	Parameter Type	Default value	Value range		Parameter name
			Min	Max	
50420	Uint8	0	0	3	LLS2 Fuel Level Priority
50421	Uint8	3	0	6	LLS2 Fuel Level Operand
50422	Uint16	0	0	65535	LLS2 Fuel Level High level
50423	Uint16	0	0	65535	LLS2 Fuel Level Low level
50424	Uint8	0	0	1	LLS2 Fuel Level Event only
50425	Uint16	1	0	65535	LLS2 Fuel Level Average
7131	Uint8	0	0	10	Send SMS
8131	String	0	0	160	SMS Text
50430	Uint8	0	0	3	LLS3 Fuel Level Priority
50431	Uint8	3	0	6	LLS3 Fuel Level Operand
50432	Uint16	0	0	65535	LLS3 Fuel Level High level
50433	Uint16	0	0	65535	LLS3 Fuel Level Low level
50434	Uint8	0	0	1	LLS3 Fuel Level Event only
50435	Uint16	1	0	65535	LLS3 Fuel Level Average
7132	Uint8	0	0	10	Send SMS
8132	String	0	0	160	SMS Text
50440	Uint8	0	0	3	LLS4 Fuel Level Priority
50441	Uint8	3	0	6	LLS4 Fuel Level Operand
50442	Uint16	0	0	65535	LLS4 Fuel Level High level
50443	Uint16	0	0	65535	LLS4 Fuel Level Low level
50444	Uint8	0	0	1	LLS4 Fuel Level Event only
50445	Uint16	1	0	65535	LLS4 Fuel Level Average
7133	Uint8	0	0	10	Send SMS
8133	String	0	0	160	SMS Text
50450	Uint8	0	0	3	LLS5 Fuel Level Priority
50451	Uint8	3	0	6	LLS5 Fuel Level Operand
50452	Uint16	0	0	65535	LLS5 Fuel Level High level
50453	Uint16	0	0	65535	LLS5 Fuel Level Low level
50454	Uint8	0	0	1	LLS5 Fuel Level Event only
50455	Uint16	1	0	65535	LLS5 Fuel Level Average
7134	Uint8	0	0	10	Send SMS
8134	String	0	0	160	SMS Text
50460	Uint8	0	0	3	LLS1 Temperature Priority
50461	Uint8	3	0	6	LLS1 Temperature Operand
50462	Int8	0	-128	127	LLS1 Temperature High level
50463	Int8	0	-128	127	LLS1 Temperature Low level
50464	Uint8	0	0	1	LLS1 Temperature Event only
50465	Uint16	1	0	65535	LLS1 Temperature Average
7135	Uint8	0	0	10	Send SMS
8135	String	0	0	160	SMS Text
50470	Uint8	0	0	3	LLS2 Temperature Priority
50471	Uint8	3	0	6	LLS2 Temperature Operand
50472	Int8	0	-128	127	LLS2 Temperature High level
50473	Int8	0	-128	127	LLS2 Temperature Low level
50474	Uint8	0	0	1	LLS2 Temperature Event only
50475	Uint16	1	0	65535	LLS2 Temperature Average
7136	Uint8	0	0	10	Send SMS

Parameter ID	Parameter Type	Default value	Value range		Parameter name
			Min	Max	
8136	String	0	0	160	SMS Text
50480	Uint8	0	0	3	LLS3 Temperature Priority
50481	Uint8	3	0	6	LLS3 Temperature Operand
50482	Int8	0	-128	127	LLS3 Temperature High level
50483	Int8	0	-128	127	LLS3 Temperature Low level
50484	Uint8	0	0	1	LLS3 Temperature Event only
50485	Uint16	1	0	65535	LLS3 Temperature Average
7137	Uint8	0	0	10	Send SMS
8137	String	0	0	160	SMS Text
50490	Uint8	0	0	3	LLS4 Temperature Priority
50491	Uint8	3	0	6	LLS4 Temperature Operand
50492	Int8	0	-128	127	LLS4 Temperature High level
50493	Int8	0	-128	127	LLS4 Temperature Low level
50494	Uint8	0	0	1	LLS4 Temperature Event only
50495	Uint16	1	0	65535	LLS4 Temperature Average
7138	Uint8	0	0	10	Send SMS
8138	String	0	0	160	SMS Text
50500	Uint8	0	0	3	LLS5 Temperature Priority
50501	Uint8	3	0	6	LLS5 Temperature Operand
50502	Int8	0	-128	127	LLS5 Temperature High level
50503	Int8	0	-128	127	LLS5 Temperature Low level
50504	Uint8	0	0	1	LLS5 Temperature Event only
50505	Uint16	1	0	65535	LLS5 Temperature Average
7139	Uint8	0	0	10	Send SMS
8139	String	0	0	160	SMS Text

9.14 OBD II (Bluetooth)

9.14.1 1st OBD II (Bluetooth) property parameter priority (ID=40100)

Parameter defines OBD II property type of priority: 0 is disabled, 1 – low, 2 – high, 3 - panic.

Minimum value	Maximum value	Default value	Goes with (depends on) parameters	Value type
0	3	0	1st OBD II (Bluetooth) property parameter operand (ID=40101) 1st OBD II (Bluetooth) property parameter High level (ID=40102) 1st OBD II (Bluetooth) property parameter Low level (ID=40103) 1st OBD II (Bluetooth) property parameter Event only (ID=40104) 1st OBD II (Bluetooth) property parameters Send SMS to (ID=7038) 1st OBD II (Bluetooth) property parameters SMS Text (ID=8038)	Uint8

9.14.2 1st OBD II (Bluetooth) property parameter operand (ID=40101)

Parameter defines when event is sent: 0 – on range exit, 1 – on range entrance, 2 – both, 3 – monitoring, 4 – hysteresis, 5 – on changes, 6 – on delta change.

Minimum value	Maximum value	Default value	Goes with (depends on) parameters	Value type
0	6	3	1st OBD II (Bluetooth) property parameter priority (ID=40100) 1st OBD II (Bluetooth) property parameter High level (ID=40102) 1st OBD II (Bluetooth) property parameter Low level (ID=40103) 1st OBD II (Bluetooth) property parameter Event only (ID=40104) 1st OBD II (Bluetooth) property parameters Send SMS to (ID=7038) 1st OBD II (Bluetooth) property parameters SMS Text (ID=8038)	Uint8

9.14.3 1st OBD II (Bluetooth) property parameter High level (ID=40102)

Parameter defines high value of triggered OBD II property. This parameter is used to set thresholds for OBD II properties to generate events.

Minimum value	Maximum value	Default value	Goes with (depends on) parameters	Value type
0	255	0	1st OBD II (Bluetooth) property parameter priority (ID=40100) 1st OBD II (Bluetooth) property parameter operand (ID=40101) 1st OBD II (Bluetooth) property parameter Low level (ID=40103) 1st OBD II (Bluetooth) property parameter Event only (ID=40104) 1st OBD II (Bluetooth) property parameters Send SMS to (ID=7038) 1st OBD II (Bluetooth) property parameters SMS Text (ID=8038)	Uint8

9.14.4 1st OBD II (Bluetooth) property parameter Low level (ID=40103)

Parameter defines low value of triggered OBD II property. This parameter is used to set thresholds for OBD II properties to generate events.

Minimum value	Maximum value	Default value	Goes with (depends on) parameters	Value type
0	255	0	1st OBD II (Bluetooth) property parameter priority (ID=40100) 1st OBD II (Bluetooth) property parameter operand (ID=40101) 1st OBD II (Bluetooth) property parameter High level (ID=40102) 1st OBD II (Bluetooth) property parameter Event only (ID=40104) 1st OBD II (Bluetooth) property parameters Send SMS to (ID=7038) 1st OBD II (Bluetooth) property parameters SMS Text (ID=8038)	Uint8

9.14.5 1st OBD II (Bluetooth) property parameter Event only (ID=40104)

Parameter defines when OBD II element value is sent: 0 – with every AVL packet, 1 – on event only. On event means that OBD II element value is included to AVL packet only when this particular event happens. With regular, periodic records such OBD II element value is not included.

Minimal value	Maximum value	Default value	Goes with (depends on) parameters	Value type
0	1	0	1st OBD II (Bluetooth) property parameter priority (ID=40100) 1st OBD II (Bluetooth) property parameter operand (ID=40101) 1st OBD II (Bluetooth) property parameter High level (ID=40102) 1st OBD II (Bluetooth) property parameter Low level (ID=40103) 1st OBD II (Bluetooth) property parameters Send SMS to (ID=7038) 1st OBD II (Bluetooth) property parameters SMS Text (ID=8038)	Uint8

9.14.6 1st OBD II (Bluetooth) property parameters Send SMS to (ID=7038)

Enable/Disable SMS event sending. 0 – Disable, 1-10 SMS will be sent to configured GSM number.

Minimal value	Maximum value	Default value	Goes with (depends on) parameters	Value type
0	10	0	GSM Predefined Numbers (ID=6000-6009) 1st OBD II (Bluetooth) property parameter priority (ID=40100) 1st OBD II (Bluetooth) property parameter operand (ID=40101) 1st OBD II (Bluetooth) property parameter High level (ID=40102) 1st OBD II (Bluetooth) property parameter Low level (ID=40103) 1st OBD II (Bluetooth) property parameter Event only (ID=40104) 1st OBD II (Bluetooth) property parameters SMS Text (ID=8038)	Uint8

9.14.7 1st OBD II (Bluetooth) property parameters SMS Text (ID=8038)

Configure 1st OBD II (Bluetooth) I/O SMS event text here.

Minimal value	Maximum value	Default value	Goes with (depends on) parameters	Value type
0	160	Number of DTC	1st OBD II (Bluetooth) property parameter priority (ID=40100) 1st OBD II (Bluetooth) property parameter operand (ID=40101) 1st OBD II (Bluetooth) property parameter High level (ID=40102) 1st OBD II (Bluetooth) property parameter Low level (ID=40103) 1st OBD II (Bluetooth) property parameter Event only (ID=40104) 1st OBD II (Bluetooth) property parameters Send SMS to (ID=7038)	S8[160]

9.14.8 All OBD II (Bluetooth) I/O elements parameters property ID

Parameter Name	Priority	Operand	High level	Low level	Event only	Send SMS to	SMS text
Number Of DTC	40100	40101	40102	40103	40104	7038	8038
Engine Load	40110	40111	40112	40113	40114	7039	8039
Coolant Temperature	40120	40121	40122	40123	40124	7040	8040
Short Fuel Trim	40130	40131	40132	40133	40134	7041	8041
Fuel Pressure	40140	40141	40142	40143	40144	7042	8042
Intake Map	40150	40151	40152	40153	40154	7043	8043
Engine RPM	40160	40161	40162	40163	40164	7044	8044
Vehicle speed	40170	40171	40172	40173	40174	7045	8045
Timing advance	40180	40181	40182	40183	40184	7046	8046

Parameter Name	Priority	Operand	High level	Low level	Event only	Send SMS to	SMS text
Intake air temperature	40190	40191	40192	40193	40194	7047	8047
MAF	40200	40201	40202	40203	40204	7048	8048
Throttle position	40210	40211	40212	40213	40214	7049	8049
Run time since engine start	40220	40221	40222	40223	40224	7050	8050
Distance traveled MIL on	40230	40231	40232	40233	40234	7051	8051
Relative fuel rail pressure	40240	40241	40242	40243	40244	7052	8052
Direct fuel rail pressure	40250	40251	40252	40253	40254	7053	8053
Commanded EGR	40260	40261	40262	40263	40264	7054	8054
EGR error	40270	40271	40272	40273	40274	7055	8055
Fuel level	40280	40281	40282	40283	40284	7056	8056
Distance traveled since codes clear	40290	40291	40292	40293	40294	7057	8057
Barometric pressure	40300	40301	40302	40303	40304	7058	8058
Control module voltage	40310	40311	40312	40313	40314	7059	8059
Absolute load value	40320	40321	40322	40323	40324	7060	8060
Ambient air temperature	40330	40331	40332	40333	40334	7061	8061
Time run with MIL on	40340	40341	40342	40343	40344	7062	8062
Time since trouble codes cleared	40350	40351	40352	40353	40354	7063	8063
Absolute fuel rail pressure	40360	40361	40362	40363	40364	7064	8064
Hybrid battery pack remaining life	40370	40371	40372	40373	40374	7065	8065
Engine oil temperature	40380	40381	40382	40383	40384	7066	8066
Fuel injection timing	40390	40391	40392	40393	40394	7067	8067
Fuel Rate	40400	40401	40402	40403	40404	7068	8068

All OBD II (Bluetooth) I/O parameters configuration settings are described in “FMB1YX Protocols” document.

9.15 LVCAN

9.15.1 LVCAN Mode (ID = 45000)

Sets LVCAN mode: 0 – Auto Detect, 1 – LV-CAN200, 2 – ALL-CAN300.

Minimum value	Maximum value	Default value	Goes with (depends on) parameters	Value type
0	2	0	Send data with 0, if ignition is off (ID = 45001) Program Number (ID = 45002)	Uint8

9.15.2 Send data with 0, if ignition is off (ID = 45001)

This parameter enables/disables data sending with 0 value, if ignition is off. 0 – Disable, 1 – Enable.

Minimum value	Maximum value	Default value	Goes with (depends on) parameters	Value type
0	1	0	LVCAN Mode (ID = 45000) Program Number (ID = 45002)	Uint8

9.15.3 Program Number (ID = 45002)

Sets LVCAN Program number.

Minimum value	Maximum value	Default value	Goes with (depends on) parameters	Value type
0	999	0	LVCAN Mode (ID = 45000) Send data with 0, if ignition is off (ID = 45001)	Uint16

9.15.4 1st LVCAN property parameter priority (ID=45100)

Parameter defines LVCAN property type of priority: 0 is disabled, 1 – low, 2 – high, 3 - panic.

Minimum value	Maximum value	Default value	Goes with (depends on) parameters	Value type
0	3	0	1st LVCAN property parameter operand (ID=45101) 1st LVCAN property parameter High level (ID=45102) 1st LVCAN property parameter Low level (ID=45103) 1st LVCAN property parameter Event only (ID=45104) 1st LVCAN property parameter averaging constant (ID=45105) 1st LVCAN property parameters Send SMS to (ID=7141) 1st LVCAN property parameters SMS Text (ID=8141)	Uint8

9.15.5 1st LVCAN property parameter operand (ID=45101)

Parameter defines when event is sent: 0 – on range exit, 1 – on range entrance, 2 – both, 3 – monitoring, 4 – hysteresis, 5 – on changes, 6 – on delta change.

Minimum value	Maximum value	Default value	Goes with (depends on) parameters	Value type
0	6	3	1st LVCAN property parameter priority (ID=45100) 1st LVCAN property parameter High level (ID=45102) 1st LVCAN property parameter Low level (ID=45103) 1st LVCAN property parameter Event only (ID=45104) 1st LVCAN property parameter averaging constant (ID=45105) 1st LVCAN property parameters	Uint8

			Send SMS to (ID=7141) 1st LVCAN property parameters SMS Text (ID=8141)	
--	--	--	--	--

9.15.6 1st LVCAN property parameter High level (ID=45102)

Parameter defines high value of triggered LVCAN property. This parameter is used to set thresholds for LVCAN properties to generate events.

Minimum value	Maximum value	Default value	Goes with (depends on) parameters	Value type
0	255	0	1st LVCAN property parameter priority (ID=45100) 1st LVCAN property parameter operand (ID=45101) 1st LVCAN property parameter Low level (ID=45103) 1st LVCAN property parameter Event only (ID=45104) 1st LVCAN property parameter averaging constant (ID=45105) 1st LVCAN property parameters Send SMS to (ID=7141) 1st LVCAN property parameters SMS Text (ID=8141)	Uint8

9.15.7 1st LVCAN property parameter Low level (ID=45103)

Parameter defines low value of triggered LVCAN property. This parameter is used to set thresholds for LVCAN properties to generate events.

Minimum value	Maximum value	Default value	Goes with (depends on) parameters	Value type
0	255	0	1st LVCAN property parameter priority (ID=45100) 1st LVCAN property parameter operand (ID=45101) 1st LVCAN property parameter High level (ID=45102) 1st LVCAN property parameter Event only (ID=45104) 1st LVCAN property parameter averaging constant (ID=45105) 1st LVCAN property parameters Send SMS to (ID=7141) 1st LVCAN property parameters SMS Text (ID=8141)	Uint8

9.15.8 1st LVCAN property parameter Event only (ID=45104)

Parameter defines when LVCAN element value is sent: 0 – with every AVL packet, 1 – on event only. On event means that LVCAN element value is included to AVL packet only when this

particular event happens. With regular, periodic records such LVCAN element value is not included.

Minimal value	Maximum value	Default value	Goes with (depends on) parameters	Value type
0	1	0	1st LVCAN property parameter priority (ID=45100) 1st LVCAN property parameter operand (ID=45101) 1st LVCAN property parameter High level (ID=45102) 1st LVCAN property parameter Low level (ID=45103) 1st LVCAN property parameter averaging constant (ID=45105) 1st LVCAN property parameters Send SMS to (ID=7141) 1st LVCAN property parameters SMS Text (ID=8141)	Uint8

9.15.9 1st LVCAN property parameter averaging constant (ID=45105)

Parameter defines LVCAN property sample length to average.

Minimum value	Maximum value	Default value	Goes with (depends on) parameters	Value type
0	65535	10	1st LVCAN property parameter priority (ID=45100) 1st LVCAN property parameter operand (ID=45101) 1st LVCAN property parameter High level (ID=45102) 1st LVCAN property parameter Low level (ID=45103) 1st LVCAN property parameter Event only (ID=45104) 1st LVCAN property parameters Send SMS to (ID=7141) 1st LVCAN property parameters SMS Text (ID=8141)	Uint16

9.15.10 1st LVCAN property parameters Send SMS to (ID=7141)

Enable/Disable SMS event sending. 0 – Disable, 1-10 SMS will be sent to configured GSM number.

Minimal value	Maximum value	Default value	Goes with (depends on) parameters	Value type
0	10	0	1st LVCAN property parameter priority (ID=45100) 1st LVCAN property parameter operand (ID=45101) 1st LVCAN property parameter High level (ID=45102) 1st LVCAN property parameter Low level (ID=45103) 1st LVCAN property parameter Event only (ID=45104) 1st LVCAN property parameter averaging constant (ID=45105) 1st LVCAN property parameters SMS Text (ID=8141)	Uint8

9.15.11 1st LVCAN property parameters SMS Text (ID=8141)

Configure 1st LVCAN property parameter SMS event text here.

Minimal value	Maximum value	Default value	Goes with (depends on) parameters	Value type
0	160	LVC Vehicle speed	1st LVCAN property parameter priority (ID=45100) 1st LVCAN property parameter operand (ID=45101) 1st LVCAN property parameter High level (ID=45102) 1st LVCAN property parameter Low level (ID=45103) 1st LVCAN property parameter Event only (ID=45104) 1st LVCAN property parameter averaging constant (ID=45105) 1st LVCAN property parameters Send SMS to (ID=7141)	String

9.15.12 All LVCAN I/O elements parameters property ID

Parameter Name	Priority	Operand	High level	Low level	Event only	Avg const	Send SMS to	SMS text
Vehicle Speed	45100	45101	45102	45103	45104	45105	7141	8141
Acceleration Pedal Position (percent)	45110	45111	45112	45113	45114	45115	7142	8142
Fuel Consumed (liters)	45120	45121	45122	45123	45124	-	7143	8143
Fuel Level (liters)	45130	45131	45132	45133	45134	45135	7144	8144
Engine RPM	45140	45141	45142	45143	45144	45145	7145	8145
Total Mileage	45150	45151	45152	45153	45154	-	7146	8146
Fuel Level (percent)	45160	45161	45162	45163	45164	45165	7147	8147
Door Status	45170	45171	45172	45173	45174	-	7148	8148
Program Number	45180	45181	45182	45183	45184	-	7149	8149

Parameter Name	Priority	Operand	High level	Low level	Event only	Avg const	Send SMS to	SMS text
Module ID	45190	45191	45192	45193	45194	-	7150	8150
Engine Worktime	45200	45201	45202	45203	45204	-	7151	8151
Engine Worktime (counted)	45210	45211	45212	45213	45214	-	7152	8152
Total Mileage (counted)	45220	45221	45222	45223	45224	-	7153	8153
Fuel Consumed (counted)	45230	45231	45232	45233	45234	-	7154	8154
Fuel Rate	45240	45241	45242	45243	45244	45245	7155	8155
AdBlue Level (percent)	45250	45251	45252	45253	45254	45255	7156	8156
AdBlue Level (liters)	45260	45261	45262	45263	45264	45265	7157	8157
Engine Load (percent)	45270	45271	45272	45273	45274	45275	7158	8158
Engine Temperature	45280	45281	45282	45283	45284	45285	7159	8159
Axle 1 Load	45290	45291	45292	45293	45294	45295	7160	8160
Axle 2 Load	45300	45301	45302	45303	45304	45305	7161	8161
Axle 3 Load	45310	45311	45312	45313	45314	45315	7162	8162
Axle 4 Load	45320	45321	45322	45323	45324	45325	7163	8163
Axle 5 Load	45330	45331	45332	45333	45334	45335	7164	8164
Control State Flags	45340	45341	45342	45343	45344	-	7165	8165
Agricultural Machinery Flags	45350	45351	45352	45353	45354	-	7166	8166
Harvesting Time	45360	45361	45362	45363	45364	-	7167	8167
Area of Harvest	45370	45371	45372	45373	45374	-	7168	8168
Mowing Efficiency	45380	45381	45382	45383	45384	45385	7169	8169
Grain Mown Volume	45390	45391	45392	45393	45394	-	7170	8170
Grain Moisture	45400	45401	45402	45403	45404	45405	7171	8171
Harvesting Drum RPM	45410	45411	45412	45413	45414	45415	7172	8172
Gap Under Harvesting Drum	45420	45421	45422	45423	45424	45425	7173	8173
Security State Flags	45430	45431	45432	45433	45434	-	7174	8174
Tachograph Total Vehicle Distance	45440	45441	45442	45443	45444	-	7175	8175
Trip Distance	45450	45451	45452	45453	45454	-	7176	8176
Tachograph Vehicle Speed	45460	45461	45462	45463	45464	45465	7177	8177
Tachograph Driver Card Presence	45470	45471	45472	45473	45474	-	7178	8178
Driver 1 States	45480	45481	45482	45483	45484	-	7179	8179
Driver 2 States	45490	45491	45492	45493	45494	-	7180	8180
Driver 1 Continuous Driving Time	45500	45501	45502	45503	45504	-	7181	8181
Driver 2 Continuous Driving Time	45510	45511	45512	45513	45514	-	7182	8182
Driver 1 Cumulative Break Time	45520	45521	45522	45523	45524	-	7183	8183
Driver 2 Cumulative Break Time	45530	45531	45532	45533	45534	-	7184	8184
Driver 1 Selected Activity Duration	45540	45541	45542	45543	45544	-	7185	8185
Driver 2 Selected Activity Duration	45550	45551	45552	45553	45554	-	7186	8186
Driver 1 Cumulative Driving Time	45560	45561	45562	45563	45564	-	7187	8187
Driver 2 Cumulative Driving Time	45570	45571	45572	45573	45574	-	7188	8188

Parameter Name	Priority	Operand	High level	Low level	Event only	Avg const	Send SMS to	SMS text
Driver 1 ID High	45580	45581	45582	45583	45584	-	7189	8189
Driver 1 ID Low	45590	45591	45592	45593	45594	-	7190	8190
Driver 2 ID High	45600	45601	45602	45603	45604	-	7191	8191
Driver 2 ID Low	45610	45611	45612	45613	45614	-	7192	8192
Battery Temperature	45620	45621	45622	45623	45624	45625	7193	8193
Battery Level	45630	45631	45632	45633	45634	45635	7194	8194
DTC Faults	45640	45641	45642	45643	45644	-	7195	8195
Slope of Arm	45650	45651	45652	45653	45654	-	7196	8196
Rotation of Arm	45660	45661	45662	45663	45664	-	7197	8197
Eject of Arm	45670	45671	45672	45673	45674	-	7198	8198
Horizontal Distance Arm Vehicle	45680	45681	45682	45683	45684	-	7199	8199
Height Arm Above Ground	45690	45691	45692	45693	45694	-	7200	8200
Drill RPM	45700	45701	45702	45703	45704	-	7201	8201
Amount of Spread Salt Square Meter	45710	45711	45712	45713	45714	-	7202	8202
Battery Voltage	45720	45721	45722	45723	45724	-	7203	8203
Amount of Spread Fine Grained Salt	45730	45731	45732	45733	45734	-	7204	8204
Amount of Spread Coarse Grained Salt	45740	45741	45742	45743	45744	-	7205	8205
Amount of Spread DiMix	45750	45751	45752	45753	45754	-	7206	8206
Amount of Spread Coarse Grained Calcium	45760	45761	45762	45763	45764	-	7207	8207
Amount of Soread Calcium Chloride	45770	45771	45772	45773	45774	-	7208	8208
Amount of Spread Sodium Chloride	45780	45781	45782	45783	45784	-	7209	8209
Amount of Spread Magnesium Chloride	45790	45791	45792	45793	45794	-	7210	8210
Amount of Spread Gravel	45800	45801	45802	45803	45804	-	7211	8211
Amount of Spread Sand	45810	45811	45812	45813	45814	-	7212	8212
Width Pouring Left	45820	45821	45822	45823	45824	-	7213	8213
Width Pouring Right	45830	45831	45832	45833	45834	-	7214	8214
Salt Spreader Working Hours	45840	45841	45842	45843	45844	-	7215	8215
Sidrance During salting	45850	45851	45852	45853	45854	-	7216	8216
Load Weight	45860	45861	45862	45863	45864	-	7217	8217
Retarder Load	45870	45871	45872	45873	45874	-	7218	8218
Cruise Time	45880	45881	45882	45883	45884	-	7219	8219

All LV-CAN200/ALL-CAN300 I/O parameters configuration settings are described in “FMB1YX Protocols” document.

9.16 RS232\RS48¹

9.16.1 External UART working mode (ID=150)

FMB125 support RS232 and RS485 modes. Only one mode may be selected for work at one time.

Minimum value	Maximum value	Default value	Goes with (depends on) parameters	Value type
0	2	0	RS232 working mode (ID=151) RS232 Baudrate (ID=152) RS232 Parity (ID=153) Prefix 1 (ID=154) Prefix 2 (ID=155) Prefix 3 (ID=156) Garmin Mode Settings (ID=157) RS485 working mode (ID=160) RS485 Baudrate (ID=161) LLS 1 Address (ID=162) LLS 2 Address (ID=163) LLS 3 Address (ID=164) LLS 4 Address (ID=165) LLS 5 Address (ID=166)	Uint8

9.16.2 RS232

9.16.2.1 RS232 working mode (ID=151)

RS232 support several modes: 0 – log mode, 1 – NMEA, 2 – LLS, 3 – LCD, 4 – RFID HID, 5 – RFID MF7, 6 – Garmin FMI, 7 – TCP ASCII, 8 – TCP Binary.

Minimum value	Maximum value	Default value	Goes with (depends on) parameters	Value type
0	8	7	External UART working mode (ID=150) RS232 Baudrate (ID=152) RS232 Parity (ID=153) Prefix 1 (ID=154) Prefix 2 (ID=155) Prefix 3 (ID=156) Garmin Mode Settings (ID=157)	Uint8

9.16.2.2 RS232 Baudrate (ID=152)

Every RS232 mode support different Baudrate: 0 – default, 1 – 1200, 2 – 2400, 3 – 9600, 4 – 14400, 5 – 19200, 6 – 38400, 7 – 57600, 8 – 115200. Every mode default Baudrate are shown in chapter RS232 Baudrate and parity, table 14.

¹ Only support FMB125 device

Minimum value	Maximum value	Default value	Goes with (depends on) parameters	Value type
0	8	Depend on selected Mode	External UART working mode (ID=150) RS232 working mode (ID=151) RS232 Parity (ID=153) Prefix 1 (ID=154) Prefix 2 (ID=155) Prefix 3 (ID=156) Garmin Mode Settings (ID=157)	Uint8

9.16.2.3 RS232 Parity (ID=153)

Every RS232 mode support different parity: 0 – default, 1 – None, 2 – Odd, 3 – Even. Every mode default parity are shown in chapter RS232 Baudrate and parity, table 14.

Minimum value	Maximum value	Default value	Goes with (depends on) parameters	Value type
0	3	Depend on selected Mode	External UART working mode (ID=150) RS232 working mode (ID=151) RS232 Baudrate (ID=152) Prefix 1 (ID=154) Prefix 2 (ID=155) Prefix 3 (ID=156) Garmin Mode Settings (ID=157)	Uint8

9.16.3 RS232 TCP Binary Mode Settings

9.16.3.1 Prefix 1 (ID=154)

Prefix 1 for advanced data filtering in RS232 TCP Binary mode.

Minimum value	Maximum value	Default value	Goes with (depends on) parameters	Value type
0	255	0	External UART working mode (ID=150) RS232 working mode (ID=151) RS232 Baudrate (ID=152) RS232 Parity (ID=153) Prefix 2 (ID=155) Prefix 3 (ID=156) Garmin Mode Settings (ID=157)	Uint8

9.16.3.2 Prefix 2 (ID=155)

Prefix 2 for advanced data filtering in RS232 TCP Binary mode.

Minimum value	Maximum value	Default value	Goes with (depends on) parameters	Value type
0	255	0	External UART working mode (ID=150) RS232 working mode (ID=151) RS232 Baudrate (ID=152) RS232 Parity (ID=153) Prefix 1 (ID=154) Prefix 3 (ID=156) Garmin Mode Settings (ID=157)	Uint8

9.16.3.3 Prefix 3 (ID=156)

Prefix 3 for advanced data filtering in RS232 TCP Binary mode.

Minimum value	Maximum value	Default value	Goes with (depends on) parameters	Value type
0	255	0	External UART working mode (ID=150) RS232 working mode (ID=151) RS232 Baudrate (ID=152) RS232 Parity (ID=153) Prefix 1 (ID=154) Prefix 2 (ID=155) Garmin Mode Settings (ID=157)	Uint8

9.16.4 Garmin Mode Settings (ID=157)

Garmin FMI mode has additional filtering capabilities. It is possible to filter Ping and Unicode packets. If Ping filter will be enabled, then Ping packets will be blocked. If Unicode filter will be enabled, then Unicode packets will not be sent to server. Both filters may be enabled for simultaneous work. Possible values: 0 – No filter, 1 – Ping filter, 2 – Unicode filter, 3 – Ping and Unicode filters.

Minimum value	Maximum value	Default value	Goes with (depends on) parameters	Value type
0	3	0	External UART working mode (ID=150) RS232 working mode (ID=151) RS232 Baudrate (ID=152) RS232 Parity (ID=153) Prefix 1 (ID=154) Prefix 2 (ID=155) Prefix 3 (ID=156)	Uint8

9.16.5 RS485

9.16.5.1 RS485 working mode (ID=160)

RS485 support several modes: 0 – log mode, 1 – NMEA, 2 – LLS, 7 – TCP ASCII, 8 – TCP Binary.

Minimum value	Maximum value	Default value	Goes with (depends on) parameters	Value type
0	4	3	External UART working mode (ID=150) RS485 Baudrate (ID=161) LLS 1 Address (ID=162) LLS 2 Address (ID=163) LLS 3 Address (ID=164) LLS 4 Address (ID=165) LLS 5 Address (ID=166)	Uint8

9.16.5.2 RS485 Baudrate (ID=161)

Every RS232 mode support different Baudrate: 0 – default, 1 – 1200, 2 – 2400, 3 – 9600, 4 – 14400, 5 – 19200, 6 – 38400, 7 – 57600, 8 – 115200. Every mode default Baudrate are shown in chapter RS232 Baudrate and parity, table 14.

Minimum value	Maximum value	Default value	Goes with (depends on) parameters	Value type
0	8	Depends on selected mode	External UART working mode (ID=150) RS485 working mode (ID=160) LLS 1 Address (ID=162) LLS 2 Address (ID=163) LLS 3 Address (ID=164) LLS 4 Address (ID=165) LLS 5 Address (ID=166)	Uint8

9.16.6 RS485 LLS Sensors

LLS addresses may be configured for 5 LLS sensors.

9.16.6.1 LLS 1 Address (ID=162)

LLS fuel level sensor 1 address.

Minimum value	Maximum value	Default value	Goes with (depends on) parameters	Value type
0	254	0	External UART working mode (ID=150) RS485 working mode (ID=160) RS485 Baudrate (ID=161) LLS 2 Address (ID=163) LLS 3 Address (ID=164) LLS 4 Address (ID=165) LLS 5 Address (ID=166)	Uint8

9.16.6.2 LLS 2 Address (ID=163)

LLS fuel level sensor 2 address.

Minimum value	Maximum value	Default value	Goes with (depends on) parameters	Value type
0	254	0	External UART working mode (ID=150) RS485 working mode (ID=160) RS485 Baudrate (ID=161) LLS 1 Address (ID=162) LLS 3 Address (ID=164) LLS 4 Address (ID=165) LLS 5 Address (ID=166)	Uint8

9.16.6.3 LLS 3 Address (ID=164)

LLS fuel level sensor 3 address.

Minimum value	Maximum value	Default value	Goes with (depends on) parameters	Value type
0	254	0	External UART working mode (ID=150) RS485 working mode (ID=160) RS485 Baudrate (ID=161) LLS 1 Address (ID=162) LLS 2 Address (ID=163) LLS 4 Address (ID=165) LLS 5 Address (ID=166)	Uint8

9.16.6.4 LLS 4 Address (ID=165)

LLS fuel level sensor 4 address.

Minimum value	Maximum value	Default value	Goes with (depends on) parameters	Value type
0	254	0	External UART working mode (ID=150) RS485 working mode (ID=160) RS485 Baudrate (ID=161) LLS 1 Address (ID=162) LLS 2 Address (ID=163) LLS 3 Address (ID=164) LLS 5 Address (ID=166)	Uint8

9.16.6.5 LLS 5 Address (ID=166)
LLS fuel level sensor 5 address.

Minimum value	Maximum value	Default value	Goes with (depends on) parameters	Value type
0	254	0	External UART working mode (ID=150) RS485 working mode (ID=160) RS485 Baudrate (ID=161) LLS 1 Address (ID=162) LLS 2 Address (ID=163) LLS 3 Address (ID=164) LLS 4 Address (ID=165)	Uint8

10 MOUNTING RECOMMENDATIONS

10.1 Connecting Wires

- Wires should be connected while module is not plugged in.
- Wires should be fastened to the other wires or non-moving parts. Try to avoid heat emitting and moving objects near the wires.
- The connections should not be seen very clearly. If factory isolation was removed while connecting wires, it should be applied again.
- If the wires are placed in the exterior or in places where they can be damaged or exposed to heat, humidity, dirt, etc., additional isolation should be applied.
- Wires cannot be connected to the board computers or control units.

10.2 Connecting Power Source

- Be sure that after the car computer falls asleep, power is still available on chosen wire. Depending on car, this may happen in 5 to 30 minutes period.
- When module is connected, measure voltage again to make sure it did not decrease.
- It is recommended to connect to the main power cable in the fuse box.
- Use 3A, 125V external fuse.

10.3 Connecting Ignition Wire

- Be sure to check if it is a real ignition wire – power does not disappear while starting the engine.
- Check if this is not an ACC wire (when key is in the first position, most electronics of the vehicle are available).
- Check if power is still available when you turn off any of vehicles devices.
- Ignition is connected to the ignition relay output. As alternative, any other relay, which has power output when ignition is on, may be chosen.

10.4 Connecting Ground Wire

- Ground wire is connected to the vehicle frame or metal parts that are fixed to the frame.

- If the wire is fixed with the bolt, the loop must be connected to the end of the wire.
- For better contact scrub paint from the place where loop is connected.



PAY ATTENTION! Connecting the power supply must be carried out in a very low impedance point of on-board vehicle network. These points in the car are the battery terminals. Therefore, we recommend connecting the power of FMB1YX (GND and POWER wires) directly to the battery terminals. Another valid option is to connect the wires to the main POWER cable inside the fuse box (if there is none, then to the power supply where the fuses of vehicle's computer are), GND wire must be connected in a special point, designed to connect GND vehicle computer. Connecting the GND at an arbitrary point to the mass of the car is unacceptable, as static and dynamic potentials on the line GND will be unpredictable, which can lead to unstable FMB1YX operation and even its failure.

11 FMB1YX installation instruction

FMB120 is the device that has internal GNSS and GSM antenna.

Device should be mounted with the sticker view to the open sky (metal free). FMB120 area with sticker is shown in figure 85.

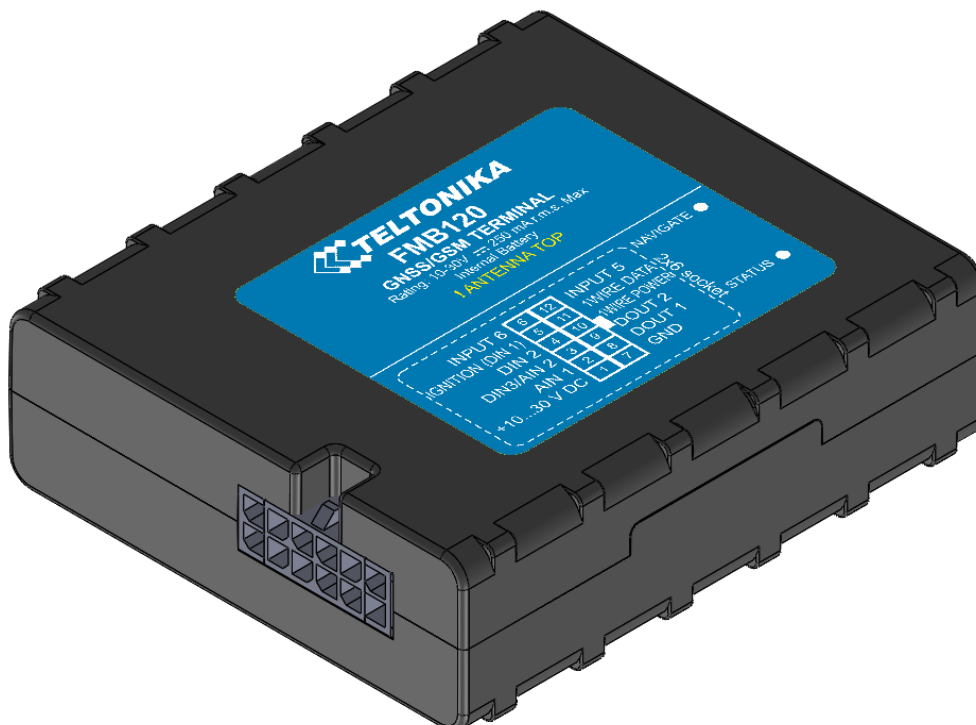

Figure 85 FMB120 view

FMB122 and FMB125 are the devices that have external GNSS antenna and internal GSM antenna. When placing GNSS antenna:

- Avoid easily reached places.
- Avoid placement under metal surfaces.
- GNSS antenna must be placed so its state is as horizontal as possible (if antenna is leant more than 30 degrees, it is considered incorrect mounting).
- GNSS antenna cable cannot be bent more than 80 degrees.
- GNSS antenna must be placed sticker facing down

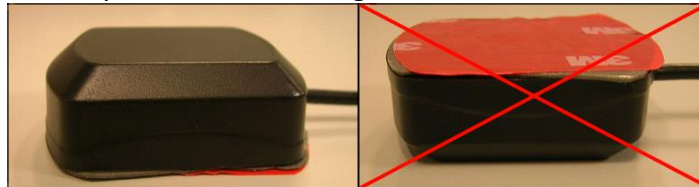

Figure 86 FMB122 and FMB125 GNSS antenna correct and wrong position

Most light vehicles has oblique front window that opens most part of interior front panel.

FMB1YX can be mounted under the plastic panel behind the front window, with the sticker direction to a window (sky). It is recommended to place FMB1YX behind dashboard as close to the window as possible. A good example of GNSS antenna placement is displayed in a picture below (area colored green).

SIM card and micro-SD card should be inserted in the module while the connector is plugged off (while module has no power).

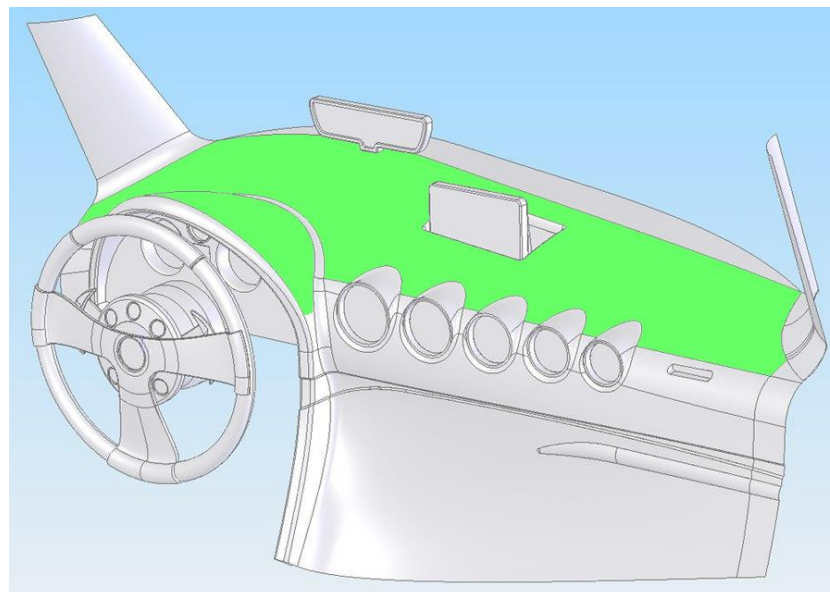

Figure 87 Correct placement of FMB1YX

12 Debug mode

FMB device is able to transmit its current state when it is connected to PC using USB cable. It is used to detect errors and provide information for solution when device is operating as unexpected. Required Terminal application can be downloaded here:

<http://avl1.teltonika.lt/Downloads/Software/Terminal.zip>

After connecting FMB device to PC, it creates two ports:

- MTK USB Debug Port – used for modem trace;
- **MTK USB Modem Port** – used for Terminal log.

If connected FMB device is not recognized by PC, please install appropriate drivers. Here is download link:

<http://avl1.teltonika.lt/Downloads/FMB1/>

After selecting your port (usually lower number port) click connect and then click on 'Start Log' button. If log is not running, please send .log:1 command (see picture below).

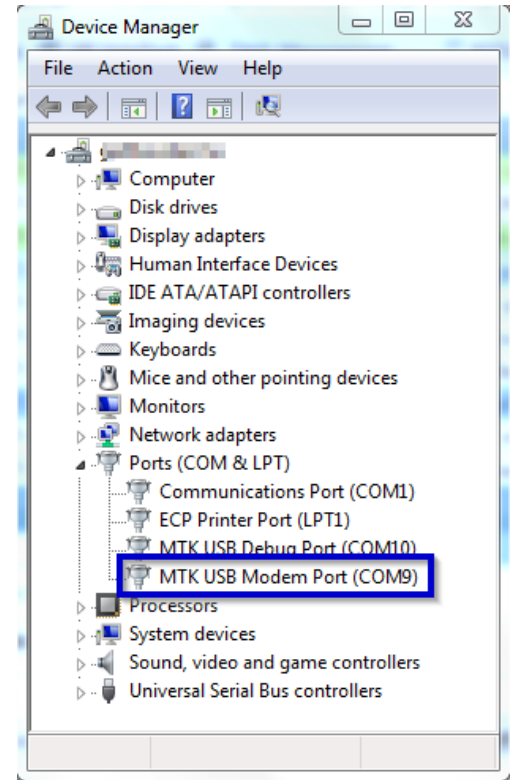

Figure 88 Ports created by FMB1YX device, market port is used for terminal log

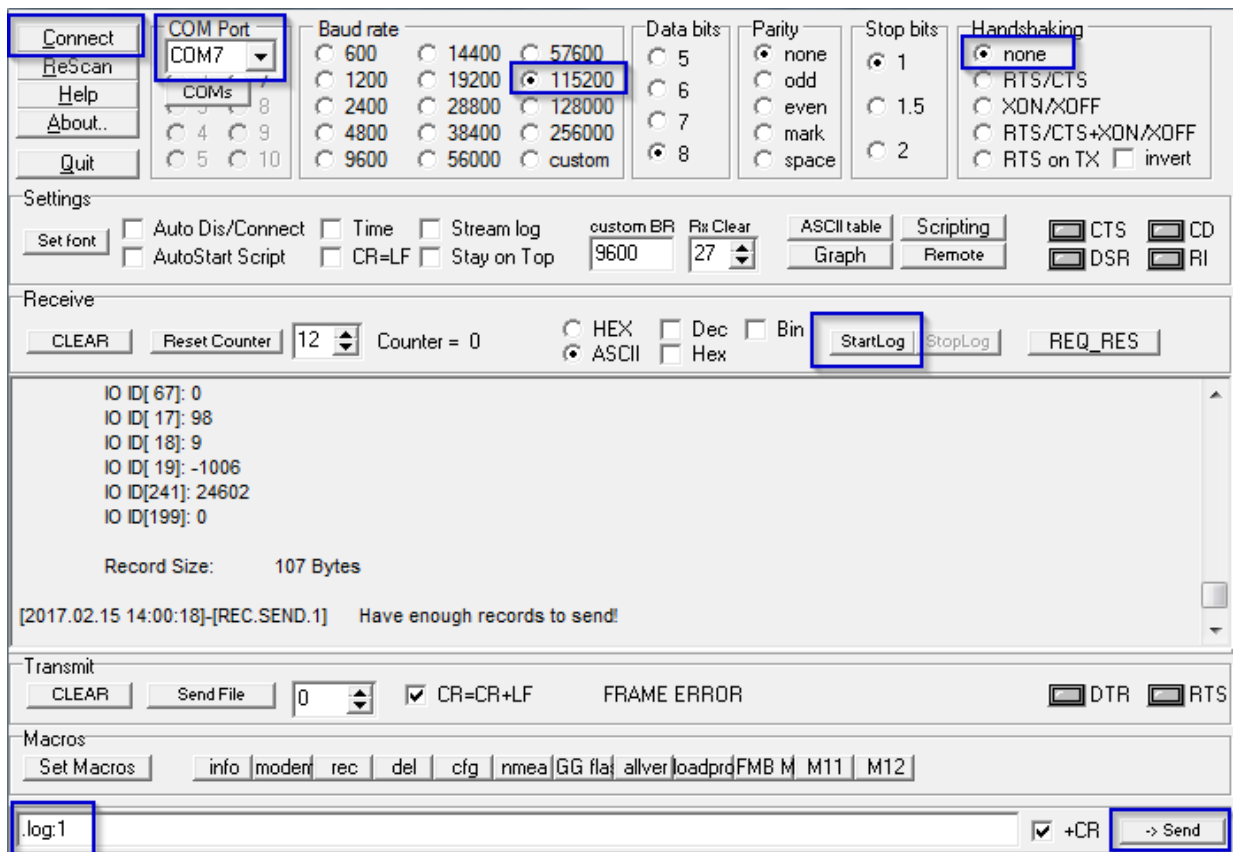

Figure 89 Terminal.exe window.

13 CHANGE LOG

Nr.	Date	Version	Comments
1	2017-07-17	0.00	Preliminary draft release.
2	2017-07-19	0.01	Preliminary draft release update.
3	2017-08-01	0.02	Added FMB122 and FMB125 devices description.
4	2017-08-02	0.03	Changed Dual Sim functionality description
5	2017-08-02	0.04	Added Navigate LED Behavior: Blinking fast constantly. Added new sms: getvin
6	2017-08-04	0.05	Updated Table 2 (Technical details) and Table 4 (Electrical characteristics tables). Added iButton read notification feature.
7	2017-08-08	0.06	Changed FMB122 Deep Sleep mode energy consumption value. Added FMB120/ FMB122 and FMB125 Online Deep Sleep energy consumption values. Changed FMB125 RS232\RS485 parameters configuration hyperlink name.
8	2017-08-09	0.07	Changed Power supply description.
9	2017-08-09	0.08	Edited Power Voltage, Input, Input Voltage, GNSS description.
10	2017-08-10	0.09	Updated Input voltage and resistance description
11	2017-09-29	0.10	Added weight data