

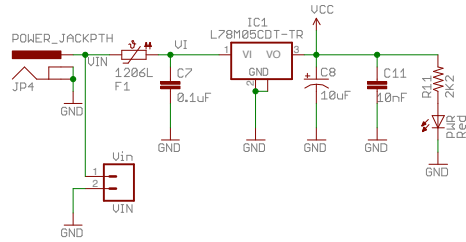

# vinciDuino evo uSD

## Power Supply



## ATMEGA 32U4

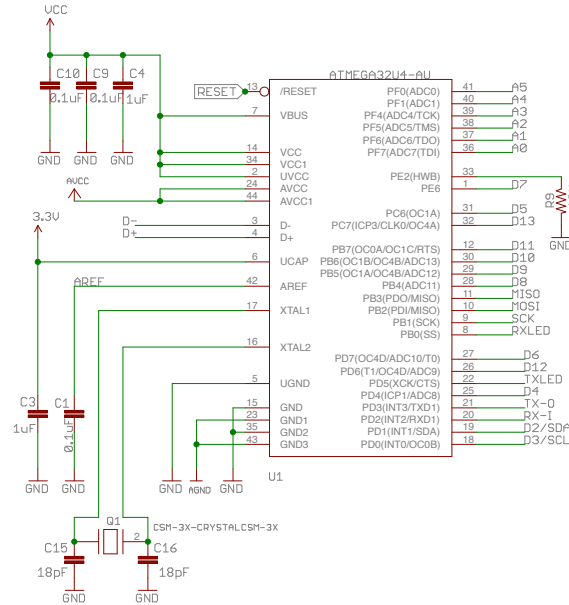

## Breakouts

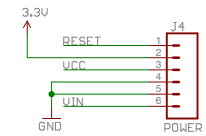
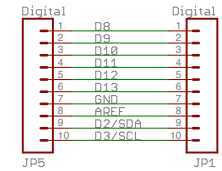
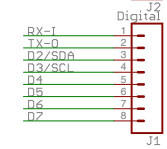
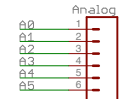

## uSD

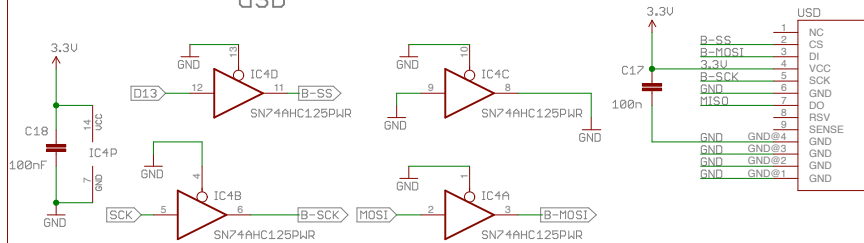

## USB

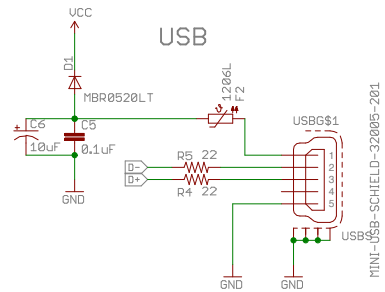

## Reset

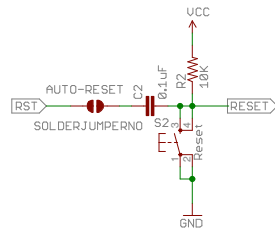

## Analog Supply

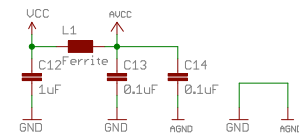

## Status LEDs

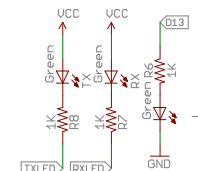

## UART

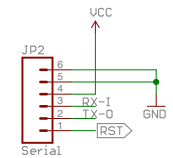

## ICSP

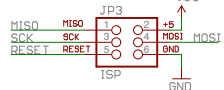

Released under the Creative Commons Attribution Share-Alike 3.0 License  
<http://creativecommons.org/licenses/by-sa/3.0>

Original form factor from Arduino Pro Mini Design by Spark Fun Electronics  
vinciDuino Design by fm - fmalpartida, Inizul, JMN and the vinciDuino Team



TITLE: vinciDuino evo uSD

Document Number:

REV: A

Date: 16/12/12 21:12

Sheet: 1/1